

Hard Disk Video Recorder Installation Manual V1.2

Statement:

Thanks for purchasing from us. Please feel free to contact our service whenever you need help.

This manual is applicable for DVR products. Features and functions vary with different products, please refer to our physical commodity and the fast manual.

This manual is your reference for operations and encodings. Related functions, specific orders, detailed menu-tree as well as fast manual are included. Please read it before installation or use.

This manual might contain some technical or print errors. Any enhancement in product features shall be added into the manual consistently without further notice.

Safety Instruction

This manual is intended to ensure that user can use the product properly without danger or any property loss. Please read it carefully and take care of it for further reference.

Precaution measures are divided into “warnings” and “cautions”, as below:

Warnings: Neglecting any of the warnings may cause death or serious injury. Cautions: Neglecting any of the cautions may cause injury or equipment damage.



Warnings

- 1 Electrical safety regulations of the nation and the region must be strictly followed during installation or use.
- 2 Please use the matched power adapter from standard company.
- 3 Do not connect multiple DVRs with one single power adapter (Overload for adapter may lead to over-heat or fire hazard).
- 4 Shut down the power while connecting or dismantling the speed dome. Do not operate with power on.
- 5 Shut down the power and unplug the power cable immediately when there is smoke, odor or noise rising from the DVR. Then contact the dealer or service center.
- 6 Please contact the local dealer or latest service center when DVR works abnormally. Do not attempt to disassemble or modify the device yourself. (We shall shoulder no responsibility for problems caused by unauthorized repair or maintenance.)



Cautions

- 1 Do not drop anything onto the dome, avoid it from physical strike. Keep it away from high electromagnetism radiation surroundings. Do not install it at vibration surface or places subjecting to strike. (Ignorance can cause equipment damage)
- 2 Keep it away from rain and moisture
- 3 Avoid exposing to direct sunlight, poor-ventilation or heat source such as heater, radiator. (Ignorance can cause fire hazard)
- 4 To avoid physical damage, extreme environment such as lampblack, water vapour, too hot or dusty are not allowed.
- 5 Please use soft and dry cloth to clean the shell. Use neutral cleaner instead of alkaline when the dirt is difficult to get rid of.

Directory

1 Product Introduction.....	7
• Product overview.....	7
• Main functions.....	7
2 Open-package check and cable connections.....	8
• open-package check.....	8
• Hard disk installation.....	9
• Shelf installation.....	9
• Front panel	10
• Economy hard disk video recorder front panel	10
• Standard hard disk video recorder front panel	11
• Enhanced front panel for hard disk video recorder	12
• High end hard disk video recorder front panel	13
• Backboard	13
• Schematic diagram of economical rear panel interface	13
• Schematic diagram of standard backboard interface	15
• Schematic diagram of enhanced backboard interface	17
• Schematic diagram of high-end backboard interface	18
• Audio and video input and output connections	19
• Video input connections	19
• Video output connections and options	20
• Video input	20
• Audio signal input	20
• Audio signal output	20
• Alarm input and output connections	21
• Alarm input port specification	22
• Alarm output port specification	23
• Alarm output port relay parameters	23
• Speed dome connections	23
3 Basic operation.....	25
• Turn on	25
• Turn off	25
• System Login	26
• Preview	27
• Boot wizard	28
• Desktop shortcut menu	33
• Main menu	33
• Record Control	34
• Playback	35
• Alarm output	37
• PTZ control	37
• Coaxial control	42
• Color setting	43
• Output Adjust	44

- Logout 45
- Window switch 45
- Quick-set 46
- IP parameter 46
- AHD&TVI&CVI Signal Switch 47
- 4 Main menu 48
 - Main menu navigation 48
 - Record 51
 - Record Configuration 51
 - Playback 52
 - Backup 52
 - Alarm Function 53
 - Motion Detect 53
 - Video Blind 56
 - Video Loss 57
 - Alarm input 58
 - Alarm output 59
 - Abnormal 59
 - Intelligent analysis 60
 - System setup 64
 - General 64
 - Encode setup 66
 - Network setup 67
 - NetService 68
 - GUI Display 78
 - PTZ device /RS485 device 79
 - RS232 80
 - Tour 81
 - Channel manage 81
 - IPC param 86
 - Advanced 86
 - HDD Manage 87
 - Account 88
 - Online user 91
 - Output adjust 91
 - Auto Maintain 91
 - Restore 92
 - Upgrade 93
 - Device Info 93
 - Import / Export 94
 - Info 94
 - HDD info 95
 - BPS 95
 - LOG 96
 - Version 97

- Shut down system 97
- 5 FAQ and maintenance 99
 - FAQ 99
 - Maintenance 100
- Appendix 1.Remote controller operation 101
- Appendix 2.Mouse operation 104
- Appendix 3.Hard disk capability calculation 107

1 Product Introduction

- **Product overview**

The series DVR is designed specially for security and defence field which is an outstanding digital surveillance product. It introduces embedded LINUX operating system which is more stable. It introduces standard H.264mp video compressed format and G.711A audio compressed format which insures the high quality image, low error coding ratio and single frame playing. It introduces TCP/IP network technology which achieves the strong network communication ability and telecommunication ability.

The series DVR can be used individually or online applied as a part of a safety surveillance network. With the professional network video surveillance software it achieves the strong network communication ability and telecommunication ability.

The series DVR can be applied in the bank, telecom, electric power system, judicial system, transportation, intelligent housing, factory, storehouse, water conservancy and so on.

- **Main functions**

Real-time surveillance

·spot interface、 analog interface、 VGA interface and HDMI interface, surveillance function through monitor or display.

Storage

·non-working hard disk dormancy processing which is convenient to radiate heat, reduce power and extend the life-span

·special storage format which insures the data safety

Compression

·real-time compression by individual hard disk which insures the audio and video signal stable synchronization

Backup

·through SATA interface and USB interface such as USB equipment, removable hard disk and so on

·through net download the files in the hard disk

Playback

- individual real-time video recording as well as searching, playback, network surveillance, recording check, downloading and so on

- multi-playback mode

- zoom at arbitrary region

Net operating

- through net tele-surveillance in the real time

- tele-PTZ control

- tele-recording check and real-time playback

Alarm linkage

- Alarm activated video record,tour ,message,buzzer,e-mail,ftp

Communication interface

- RS485 interface which fulfills the alarm input and PTZ control

- RS232 interface which can extend keyboard connection to realize master,as well as with computer serial port connection for system maintenance and upgrade,and matrix control and so on.

- standard ethernet network interface which fulfills the telecommuting function

Intelligent operating

- mouse action function

- fast copy and paste operating for the same setting

2 Open-package check and cable connections

- **open-package check**

materials used for the package of the DVR can protect most accidental clashes during transportation.Then, please open the box and get rid off the plastic protective materials. Check whether there is any visible damage to the DVR appearance.

At last, please open the machine crust and check the data wire in the front panel, power wire, the connection between the fan power and the main board.

1 Front panel and rear panel

- The key function specification in the front panel and the interface specification in the rear panel are in the specification.

- Please check the product type in the front panel whether is accordant with the product type you order.

The label in the real panel is very important for the after service. Please protect it carefully. When you contact us for after service, please provide the product type and serial number in the label.

2.Check

After open the cover,you should check if it has obvious damage trace,also please check the front panel data cable,power cord and motherboard's connection are loose or not.

• Hard disk installation

For the first use,please install the hard disk,this machine box can install two hard disk(no limited capacity).



①disassemble the screw



②disassemble the cover



③fix the screw of hard disk



④fix the screw of hard disk



⑤connect the data wire



⑥connect the power wire



⑦cover the machine

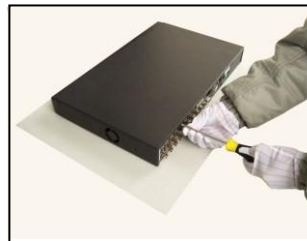

⑧fix the cover

• Shelf installation

This product chassis specification for the standard 1u,so it can be installed in the standard shelf.

Installation steps and attention items:

- 1、 Make sure the temperature in the room lower then 35°C (95°F).
- 2、 Keep the equipment have 15cm(6 inches)space around in order to air's circulation.
- 3、 From bottom to shelf installation.
- 4、 When multiple components install in the frame, please take preventive measures to avoid power socket overload..

- **Front panel**

- **Economy hard disk video recorder front panel**

1.Front-panle (1)

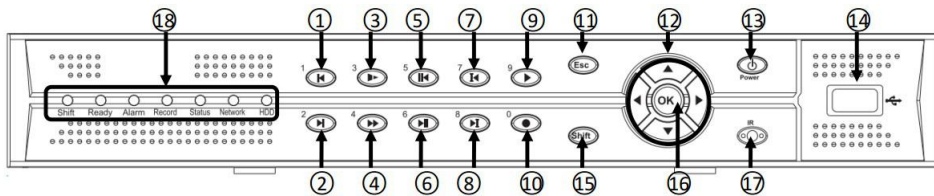

1 Front-panle (2)

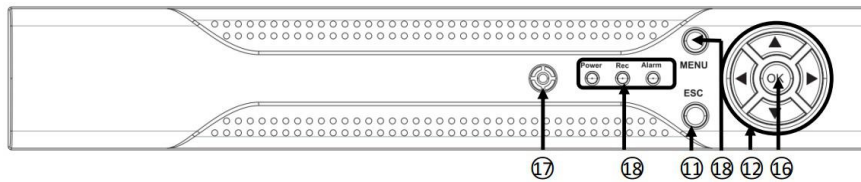

2 Function description

NO	Name	Function	NO	Name	Function
1	previous file	Play the previous file	13	Power switch	Power switch
2	Next file	Play the previous file	14	USB	USB interface
3	Slow Play	Slow Play	15	SHIFT button	Function Switch
4	Fast Play	Fast Play	16	OK button	confirm
5	Backwards Pause	Backwards Pause	17	IR receiver side	IR remote receiver
6	Play Pause	Pause play the file	18	Shift	Shift function indicator
7	Previous Frame	Play the previous frame		Ready	System indicator light
8	Next Frame	Play the Next Frame		Alarm	Alarm indicator light
9	Play	Play the file		Record	Record indicator light

10	Recording Control	Control recording		Status	Extern operation indicator
11	ESC	Cancel		Network	Network indicator light
12	Direction	Direction Control		HDD	HDD indicator light

• **Standard hard disk video recorder front panel**

1. Front-panel (1)

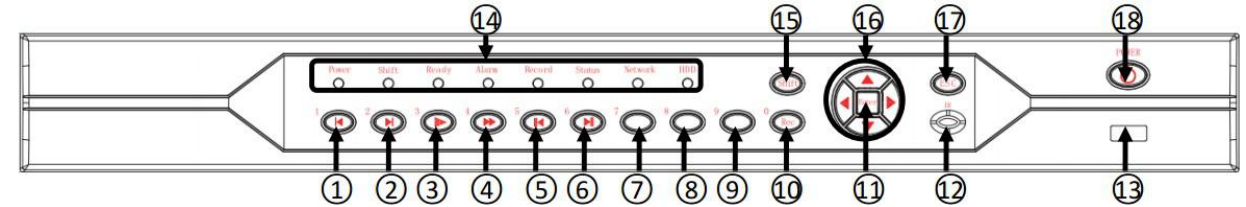

2. Front-panel (2)

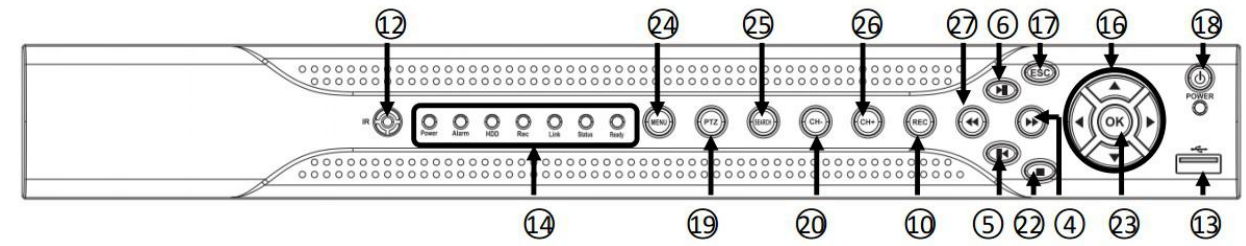

3. Function Description

NO	Name	Function	NO	Name	Function
1	previous file	Play the previous file	15	SHIFT	Function Switch
2	Next file	Play the previous file	16	Direction Control	Control Direction
3	Slow Play	Slow Play	17	ESC	Cancel
4	Fast Play	Fast Play	18	Power switch	Power switch
5	Backwards Pause	Backwards Pause	19	PTZ	PTZ Control
6	Play Pause	Pause play the file	20	CH-	Switch to previous channel
7	Previous Frame	Play the previous frame			
8	Next Frame	Play the Next Frame	22	Stop	Stop
9	Video playback	Playback Video	23	OK	Confirm
10	Recording Control	Control Recording	24	MENU	Main Menu
11	ENTER	Confirm	25	SEARCH	Search the video file
12	IR receiver side	IR remote receiver	26	CH+	Switch to next channel

13	USB	USB Interface	27	Rewind button	Rewind
14	Power	Power indicator light	14	Record	Record indicator light
	Shift	Shift function indicator		Status	External operation indicator
	Ready	System indicator light		Network	Network indicator light
	Alarm	Alarm indicator light		HDD	HDD indicator light

- Enhanced front panel for hard disk video recorder

1. Front-panel

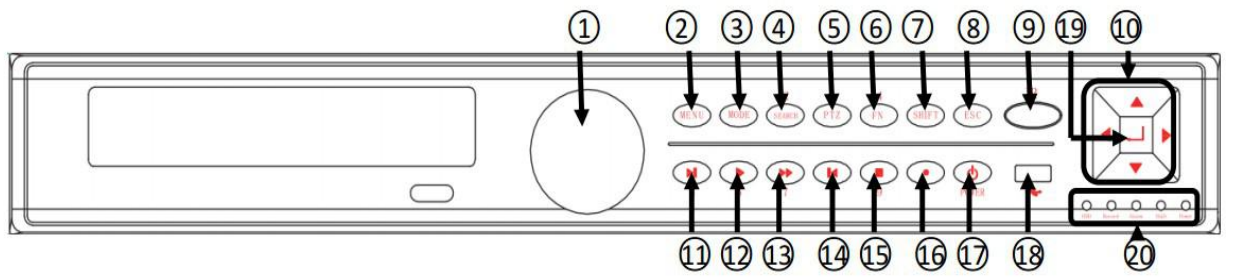

2. Function description

No	Name	Function	No	Name	Function
1	Shuttle	Shuttle	13	Fast play	Fast play/7
2	MENU	Main menu/0	14	Backwards Pause	Backwards Pause /8
3	MODE	Switch screen/1	15	Stop playback	Stop playback /9
4	SEARCH	Search Video/2	16	Control Recording	Control Recording
5	PTZ	PTZ Control/3	17	Power Switch	Power switch
6	FN	Enter the corresponding interface function auxiliary menu	18	USB	USB Interface
7	SHIFT	Function switch	19	ok	confirm
8	ESC	Cancel	20	HDD	HDD indicator light
9	IR receiver side	IR remote receiver		Record	Recording indicator light
10	Direction Control	Control direction		Alarm	Alarm indicator light
11	Play Pause	Play pause/5		Shift	Shift function indicator
12	Slow play	Slow play/6		Power	Power indicator light

- **High end hard disk video recorder front panel**

1. Front-panel

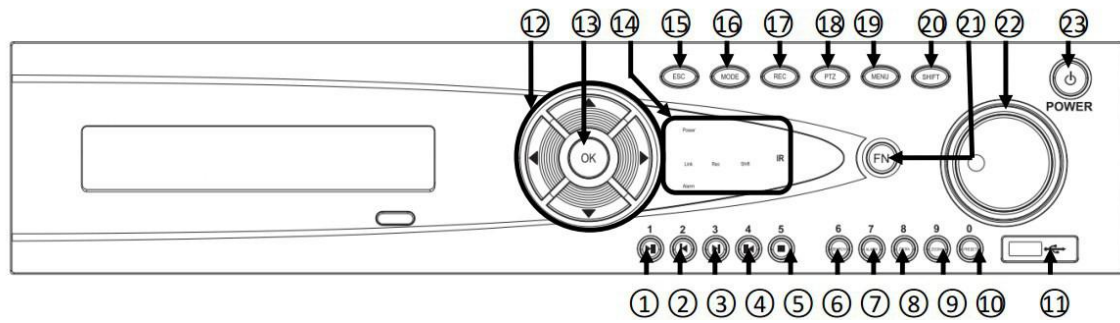

2. Function Description

No	Name	Function	No	Name	Function
1	Play pause	Play pause /1	14	Power	Power indicator light
2	Play the previous file	Play the previous file /2		Link	Network indicator light
3	Play the next file	Play the next file /3		Record	Recording indicator light
4	Backwards Pause	Backwards Pause /4		Shift	Shift function indicator
5	Playback stop	Stop playback/5		Alarm	Alarm indicator light
6	SEARCH	Search video/6	15	ESC	Cancel
7	ALARM	Alarm output/7	16	MODE	Switch screen
8	ZOOM-	PTZ control zoom-	17	REC	Control recording
9	ZOOM+	PTZ control zoom+	18	PTZ	PTZ control
10	PRESET	Preset setting/0	19	MENU	Main menu
11	USB	USB interface	20	SHIFT	Function switch
12	Direction	Control direction	21	FN	Enter the corresponding interface function auxiliary menu
13	ok	confirm	22	Shuttle	Shuttle
			23	Power	Power switch

- **Backboard**

- **Schematic diagram of economical rear panel interface**

This installation manual is illustrated by the example of economic 16 road.

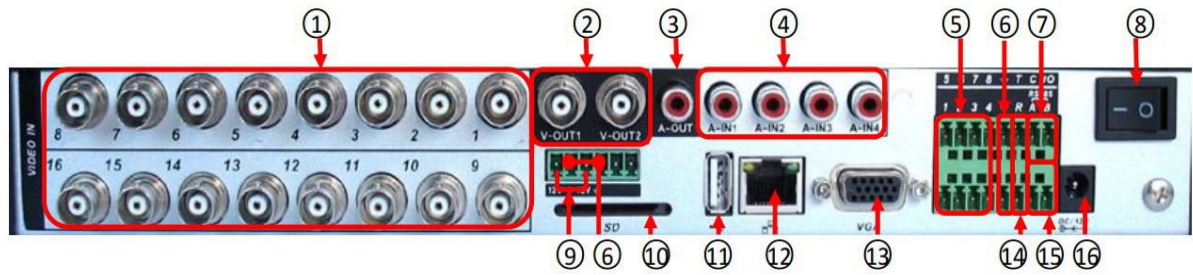

No	Name	Fucntion Description	NO	Name	Function Description
1	VIN	Video Input	9	+12/-12V	Power Supply Interface
2	VOUT	BNC output interface	10	SD card	Sd card insert
3	AOUT	Audio Output	11	USB	USB interface
4	AIN	Audio Input	12	Network por	Network Interface
5	Num1-8	Alarm Input	13	VGA	Video Output
6	GND	Ground	14	T/R	Serial port Senderand receiver interface
7	C/NO	Alarm Output	15	RS485A/B	485 Interface
8	Power	Power Switch	16	DC/12V	Power Supply

Economical 4-ch hard disk DVR:



Economical 8-ch ADVR A:



Economical 8-ch ADVR B:



Economical 8-ch ADVR C:



Economical 16-ch ADVR A:



Economical 16-ch ADVR B:



- **Schematic diagram of standard backboard interface**

This installation manual uses standard 32-ch DVR as an example.

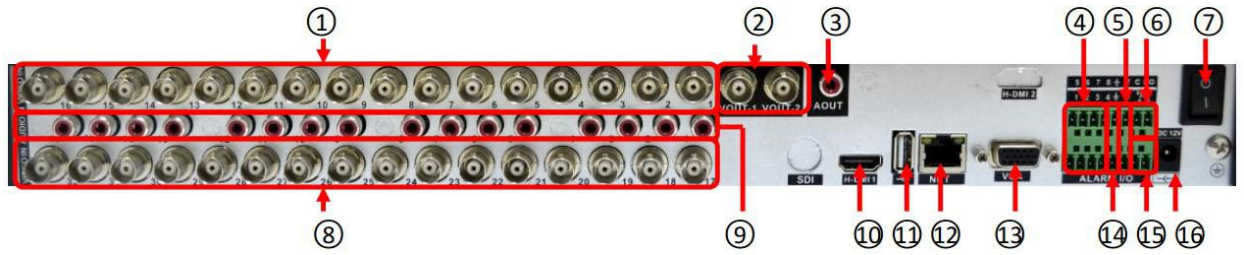

NO	Name	Function	No	Name	Function
1	VIN1-16	16-ch video input	9	A-IN	Audio input
2	VOUT	BNC output interface	10	HDMI	Video interface
3	AOUT	Audio Output	11	USB	USB interface
4	Num 1—8	Alarm Input	12	Network Port	Network interface
5	T/R	Serial port sender and receiver interface	13	VGA	Video interface
6	C/NO	Alarm Output	14	GND	Ground
7	Power	Power Switch	15	RS485	485 Interface
8	VIN17-32	16-CH Video input	16	DC/12V	Power Supply

Standard 4-ch ADVR:



Standard 8-ch ADVR A:



Standard 8-ch ADVR B



Standard 8-ch ADVR C



Standard 16-ch ADVR A



Standard 16-ch ADVR B



Standard 32-ch ADVR:

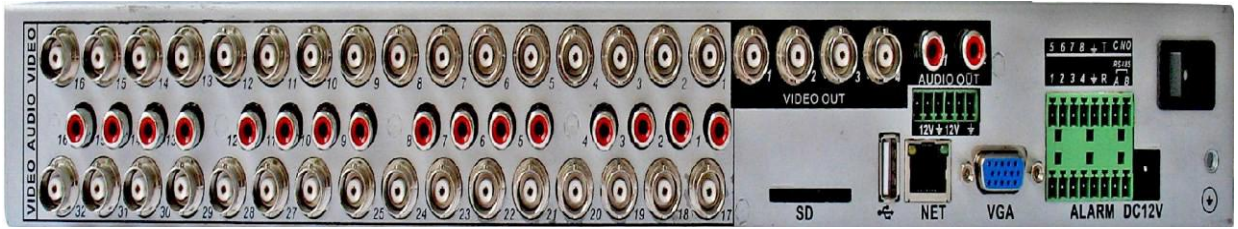

- **Schematic diagram of enhanced backboard interface**

The installation manual is take enhance the 16-ch ADVR as an example.



N	Name	Funciton	No	Name	Funciton
1	VIN	Video input	7	External interface	External interface
2	AIN	Audio Input	8	DC/12V	Power saupply
3	VGA	Video output	9	VOUT	BNC Video Output
4	HDMI	Video output	10	AOUT	Audio Output
5	Network port	Network Interface	11	Power	Power Switch
6	USB	USB Interface			

Enhanced 4-ch ADVR:



Enhanced 8-ch ADVR:



Enhanced 16-ch ADVR:



Enhanced 32-ch ADVR:



• Schematic diagram of high-end backboard interface

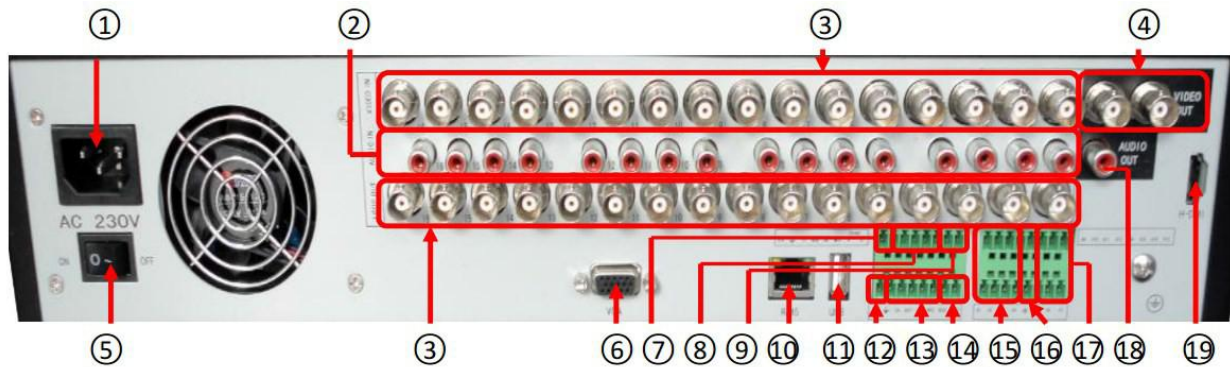

No	Name	Function	NO	Name	Function
1	AC/230V	Power Supply	11	USB	USBInterface
2	A	Audio Input	12	Alarm input	Alarm input
3	Num 1-32	Video input	13	Alarm output	Alarm output
4	VOUT	BNC Video Interface	14	RS232	Serial port sender and receiver
5	Power	Power Switch	15	Alarm input	Alarm input
6	VGA	Video Output	16	GND	Ground
7	Audio input	Audio input	17	Alarm input	Alarm input
8	Audio Output	Audio Output	18	AOUT	Audio output
9	RS485	485 Interface	19	HDMI	Video Interface
10	Network port	Network Interface			

High-end 4-ch ADVR:



High-end 8-ch ADVR:



High-end 16-ch ADVR:



- **Audio and video input and output connections**
- **Video input connections**

The video input port is BNC connector plug. The demand of input signal is PAL/NTSC BNC(1.0V_{P-P},75Ω).

The video signal must be accorded with the state standard which has the high signal to noise ratio, low aberration and low interference. The image must be clear and has natural color in the appropriate brightness.

Insure the vidicon signal stable and credible

The vidicon should be installed in the appropriate location where is away from backlighting and low illumination or adopts the better backlighting and low illumination compensation.

The ground and power supply of the vidicon and the DVR should be shared and stable.

Insure the transmission line stable and credible

The video transmission line should adopt high quality coaxial pair which is chosen by the transmission distance. If the transmission distance is too far, it should adopt shielded twisted pair, video compensation equipment and transmit by fiber to insure the signal quality.

The video signal line should be away from the electro magnetic Interference and other equipments signal lines. The high voltage current should be avoided especially.

Insure the connection stable and credible

The signal and shield lines should be firm and connected credible which avoid false and joint welding and oxidation.

- **Video output connections and options**

The video output is divided into PAL/NTSC BNC(1.0V_{P-P},75Ω) and VGA output(selective configuration).

When replace the monitor by the computer display, there are some issues to notice

- 1、 Do not stay in the turn-on state for a long time.
- 2、 Keep the computer display normal working by demagnetizing regularly.
- 3、 Stay away from the electro magnetic Interference.

TV is not a credible replacement as a video output. It demands reducing the use time and control the power supply and the interference introduced by the nearby equipments strictly. The creepage of low quality TV can lead to the damage of other equipments.

- **Video input**

In AHD-L, AHD-M, AHD-H channel mode, most models can compatible with HK, DH and other companies"camera, some models only support our own camera.

- **Audio signal input**

Audio port is BNC connection.

The input impedance is high so the tone arm must be active.

The audio signal line should be firm and away from the electro magnetic Interference and connected credible which avoid false and joint welding and oxidation. The high voltage current should be avoided especially.

- **Audio signal output**

Commonly the output parameter of DVR audio signal is greater than 200mv 1KΩ(BNC) which can connect the low impedance earphone and active sound box or other audio output equipments through

power amplifier. If the sound box and the tone arm can not be isolated, howling phenomena is often existed. There are some methods to deal with the above phenomena.

- 1、 Adopt better directional tone arm.
- 2、 Adjust the sound box volume to be under the threshold that produces the howling phenomena.
- 3、 Use fitment materials that absorb the sound to reduce reflection of the sound.
- 4、 Adjust the layout of the sound box and the tone arm.

• **Alarm input and output connections**

Before connecting the device, please pay attention to follow situations:

***note: Some series have no alarm input/output functions.**

1 **Alarm input**

- Alarm input is grounding alarm input.
- Alarm input demand is the grounding voltage signal.
- When the alarm is connected with two DVRs or connected with DVR and other equipments, it should be isolated by relay.

1 **Alarm output**

Alarm output can not be connected with high-power load (no more than 1A). When forming the output loop it must prevent the big current from relay damage. Use the contact isolator when there is a high-power load

2 **PTZ decoder connections**

- The grounding of the PTZ decoder and DVR must be shared otherwise the common-mode voltage will lead to the PTZ control failure. The shielded twisted pair is recommended.
- Avoid the entrance of high voltage. Make the layout reasonably. Take precaution from the thunder.
- In the outlying end connect 120Ω resistance paralleled to reduce the inflection and insure the signal quality.
- The 485 AB lines of DVR can not connected with other 485 output equipments paralleled.
- The voltage between the AB lines of the decoder must be less than 5V.

3 **Front equipment grounding note**

Bad grounding can lead to the burnout of the chip.

4 **Alarm input type unlimited**

The DVR alarm output port is constant opening type.

eight external alarm interface

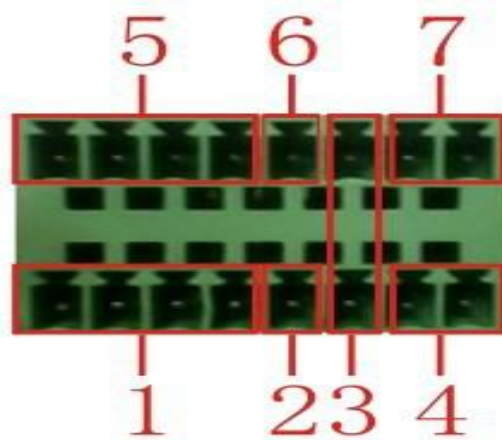

(1) alarm input 1,2,3,4 (2) ground (3) RS232 (4) RS485 (5) alarm input 5,6,7,8
 (6) ground (7) alarm output

sixteen external alarm interface

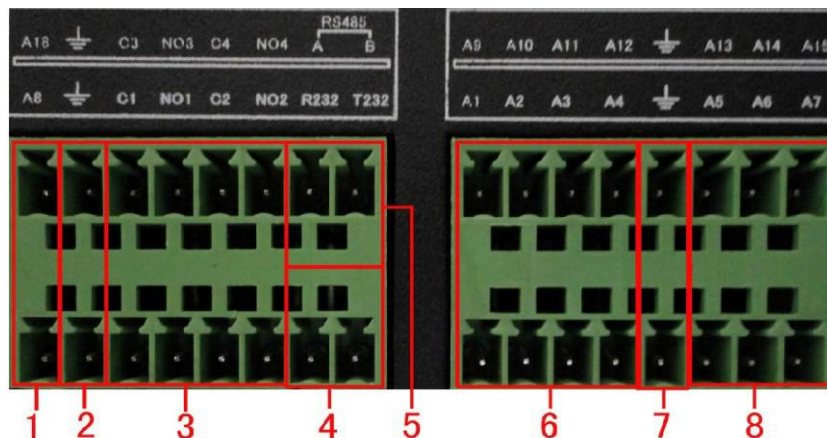

①⑥⑧alarm input ②⑦ground ③alarm output ⑤RS485 ④RS232

Parameter	meaning
G	grounding
R,T	RS232 port
A,B	485communciate interface which is connected with the recording control equipments such as the decoder

• **Alarm input port specification**

8 channels alarm input. Alarm input type unlimited.

The grounding and the com port of the alarm sensor are parallel (The alarm sensor is external power

supply) .

The grounding of the alarm and the DVR should be shared.

The NC port of the alarm sensor must be connected with the DVR alarm input port.

The grounding of the power supply and the alarm sensor must be shared when used in external power supply.

- **Alarm output port specification**

2 channels alarm output. There is external power supply when using the external alarm equipment.

Please refer to the relay relevant parameters to avoid the overload that damages main machine.

- **Alarm output port relay parameters**

Type: JRC-27F		
Interface material	silver	
rating (resistance 10Ω)	Rating switch capacity	30VDC 2A, 125VAC 1A
	maximal switch power	125VA 160W
	maximal switch	250VAC, 220VDC
	maximal switch	1A
isolation	Homo-polarity	1000VAC 1minute
	Inhomo-	1000VAC 1 minute
	Interface and winding	1000VAC 1 minute
Surge voltage	Homo-polarity	1500VAC (10×160us)
Turn-on time	3ms max	
Turn-off time	3ms max	
longevity	mechanic	50×10 ⁶ MIN (3Hz)
	electric	200×10 ³ MIN (0.5Hz)
Environment	-40~+70℃	

2.8 Speed dome connections

1.Connect the 485 lines of the speed dome with the DVR 485 interface.

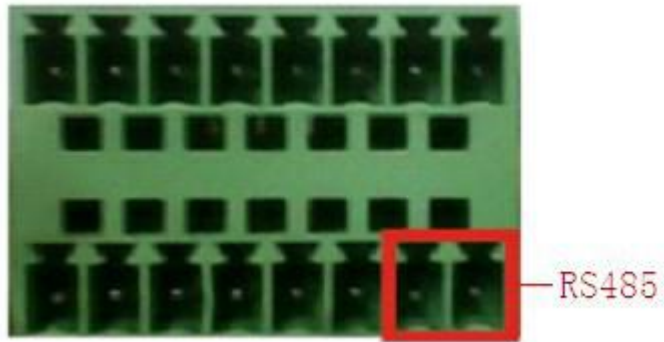

the 485 interface of eight external alarm

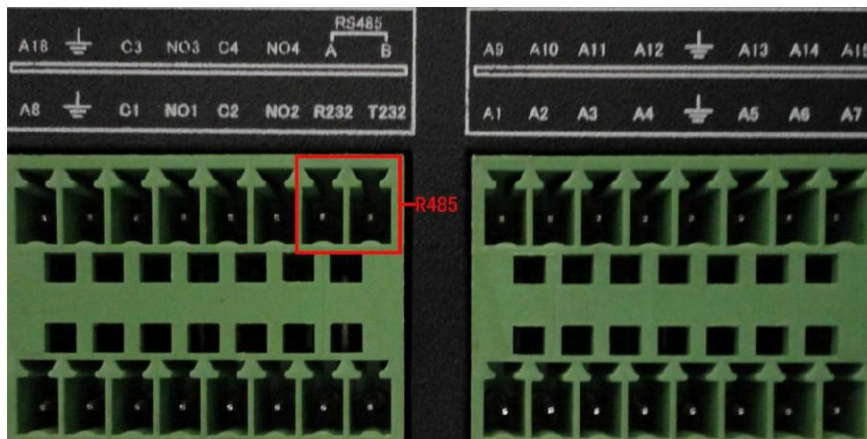

the 485 interface of sixteen external alarm

2.Connect the video line with the DVR video input.

3.Electrify the speed dome

3 Basic operation

Note: The button in gray display indicates nonsupport.

- **Turn on**

Plug the power supply and turn on the power supply switch. Power supply indicator light shining indicates turning on the video recorder. After the startup you will hear a beep. The default setting of video output is multiple-window output mode. If the startup time is within the video setting time, the timing video recording function will start up automatically. Then the video indicator light of corresponding channel is shining and the DVR is working normally.

Note: 1. Make sure that the input voltage corresponds with the switch of the DVR power supply.

2. Power supply demands: 220V±10% /50Hz.

Suggest using the UPS to protect the power supply under allowable conditions.

- **Turn off**

There are two methods to turn off the DVR. Entering [main menu] and choosing [turn off] in the [turn off the system] option is called soft switch. Pressing the power supply switch is called hard switch.

Illumination:

- 1、 Auto resume after power failure

If the DVR is shut down abnormally, it can automatically backup video and resume previous working status after power failure.

- 2、 Replace the hard disk

Before replacing the hard disk, the power supply switch in the real panel must be turned off. 3、 Replace the battery

Before replacing the battery, the setting information must be saved and the power supply switch in the real panel must be turned off. The DVR uses button battery. The system time must be checked regularly. If the time is not correct you must replace the battery, we recommend replacing the battery every year and using the same battery type.

Note: The setting information must be saved before replacing the battery otherwise information will lose.

- **System Login**

When the DVR boots up, the user must login and the system provides the corresponding functions with the user purview. There are two user settings. The names are **admin**, and **default** and these names have no password. **Admin** is the super user purview; **default**'s permissions are preview and video playback. User **admin**'s password can be revised, while their permissions can't be revised; user **default** is the default login user whose permission can be revised but not its password.



System Login

Password protection: If the password is continuous wrong three times, the alarm will start. If the password is continuous wrong five times, the account will be locked. (Through reboot or after half an hour, the account will be unlocked automatically).

Safety Question: When you forget the password, you can click "?" to enter the reset password page. Note: The default is no safety question. You can set the safety question on the account page. If the answer is continuous wrong six times, the page will be locked (you have to reboot the device to continue the operation)











Safety question

- **Preview**



Preview

The date, time, channel name, channel stream value, channel resolution, the channel signal mode (most models support), etc. are shown in each preview screen, The surveillance video and the alarm status are shown in each window.

1		Recording status	4		Video loss
2		Motion detect	5		Video blind
3		Audio	6		Camera lock
7		The maximum resolution	8		AHD&TVI&CVI&CVBS switch
9		Channel stream value (some model can support this)			

Preview icon

- **Boot wizard**

Provide fast setup to wizard configuration parameters. Including boot wizard, two-dimensional code and digital channel configuration wizard, click “Next” to enter the digital channel configuration wizard.

Boot wizard:

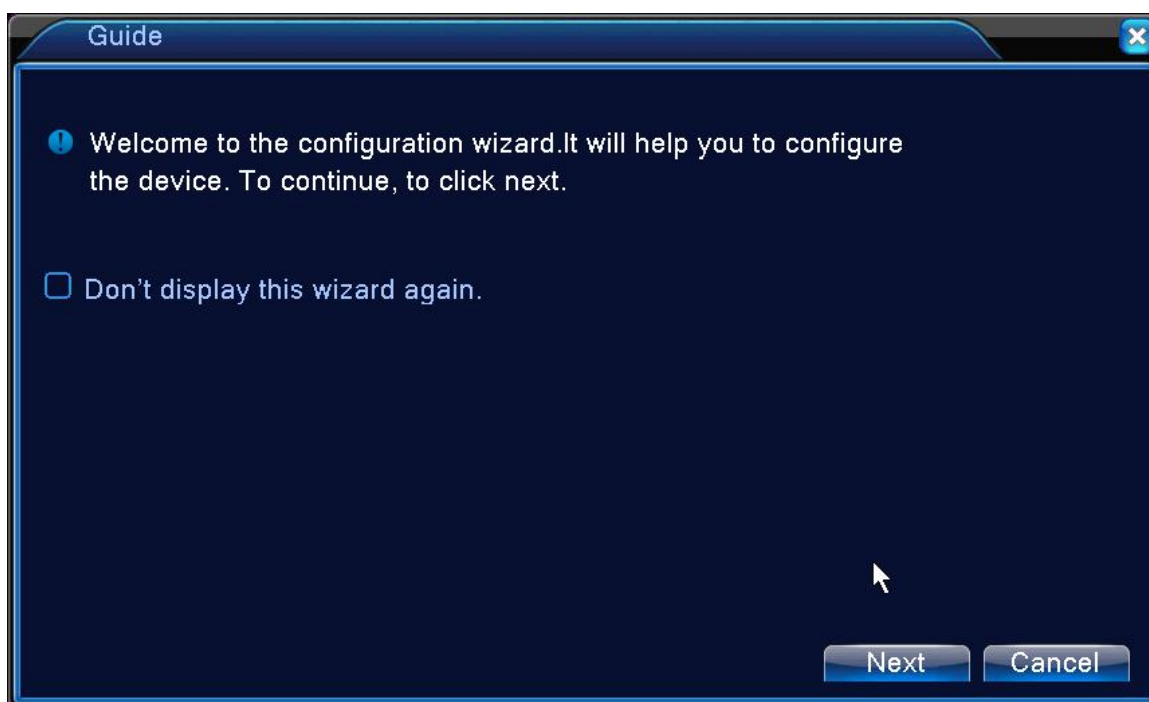

Boot wizard interface

[Do not Display] select the highlighted  expressed after reboot, no longer automatically pop up boot wizard.

[Next] enter the digital channel configuration wizard interface.

[Cancel] to save the settings and exit this screen wizard interface.

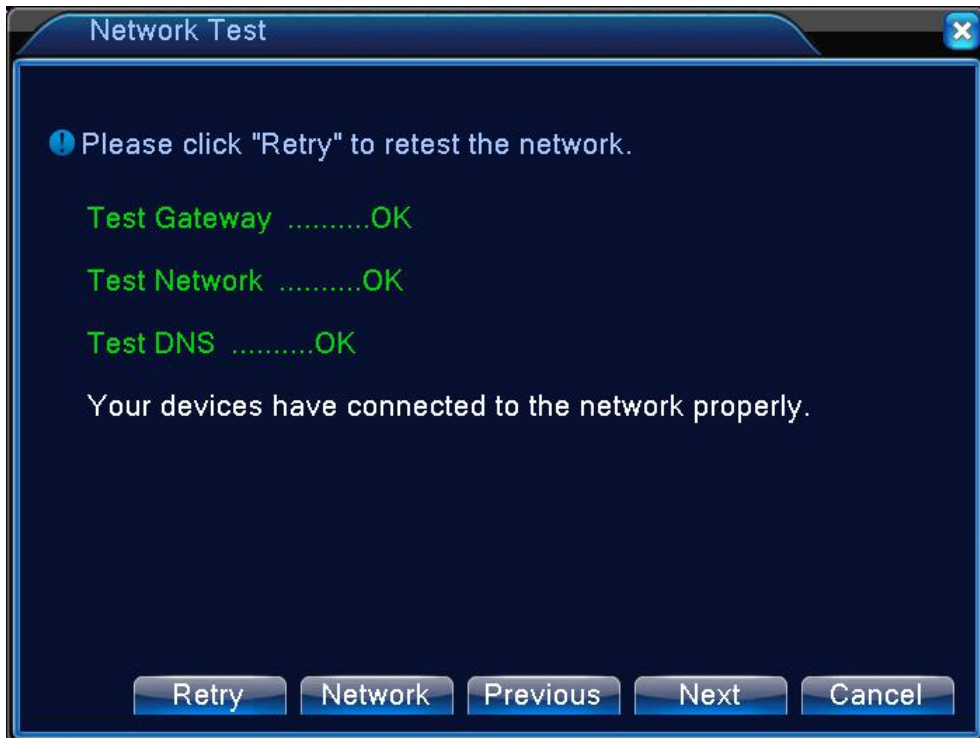

Network test

Network Test : Green OK means connect to network successfully,red ERR means failed;

【Retry】 Click ?Retry? to test the network again;

【Network】 click it to set the device network setting;

【Skip】 Click it to skip this network test

【Next】 Click ?Next?, will pop up APP and SN QR code,

QR Code



QR code interface

【Next】 Click ?Next?, will pop up mode selection.

Mode selection:

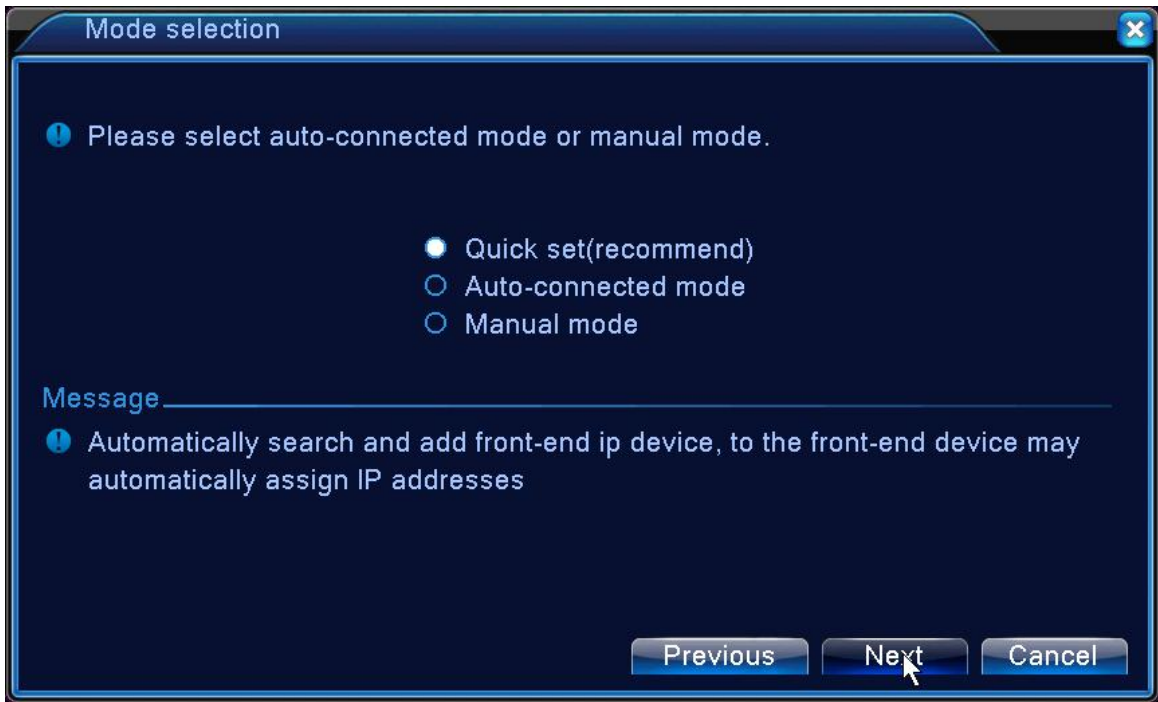

Mode selection

【Quick set】 select the Quick set to enter the digital channel configuration wizard and start to search the remote device IP in the same LAN automatically, and then add the IPC to the back-end device in accordance with the order of search, and you can cancel this process manually;

【Auto-connected mode】 The back-end device can modify the remote ipc device to the same network segment which are under the same LAN and automatically completes the addition; when the function is enabled, the boot wizard ends;

【Manual mode】 Select the manual mode to enter the digital channel configuration wizard, you can set shortcuts for digital channels;;

NOTE: After using this function, the parameters in the configuration of all digital channels will be updated, please caution.

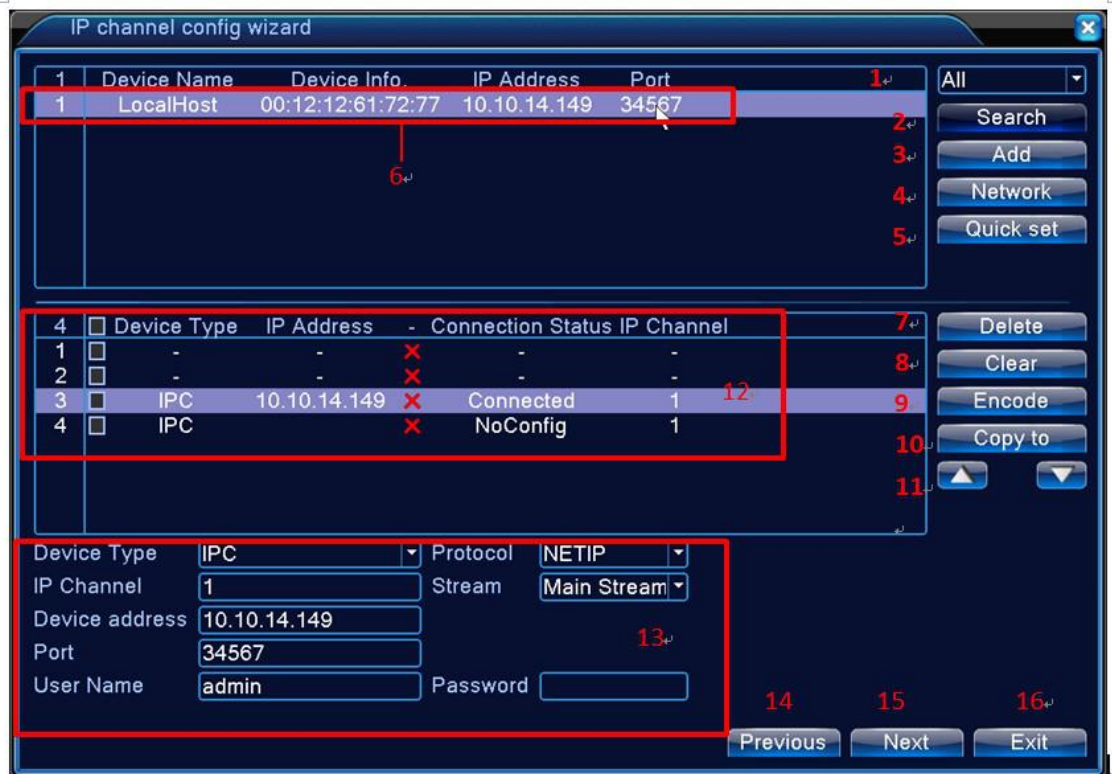

Digital Channel Configuration Wizards

Label meanings:

- Search protocol selection
Includes three search methods, respectively NETIP, ONVIF, ALL
- Search
Search device
- Add
Add device
- Network Settings
The device can be set remotely channel, user name, password; click the Network Settings button, you can set the network of the device, including IP, subnet mask, default gateway (ONVIF protocol devices cannot make network settings).



Network settings

- Hotkey settings

Configure all channels by one key.

- Equipment list display area

This area displays the discovered devices.

- Delete

Select the device has been configured, click Delete, you can delete the device

- Clear

Clear all configured channels

- encoding settings

You can set the front end configured coding

- Copy to

Some information of selected channels can be copied to other channels, such as user name, password, and other device information, as shown below:



Copy to

- Up and down keys

Click the device in the list, click up and down buttons to move the device up and down.

- Configuration Status

Configuration status of each channel, including not configured, connected, not online

- configuration front-end information

The information of the front-end configured, user name, password can be set in this area.

- Previous

Return to the previous screen and that is the boot wizard interface.

- Next

Add the selected device to the appropriate digital channels, and then enable the channel; the remaining non-selected digital channel is not enabled.

- Exit

Return to the preview screen.

- **Desktop shortcut menu**

In preview mode you can right click mouse to get a desktop shortcut menu,as the picture shows. The menu includes: main menu, Guide, Quick set, record mode, playback, IPC param,PTZ control, coaxial control,TVI&AHD signal switch、 High Speed PTZ, Alarm Output, color Setting, Output adjust, Logout, view mode shift.



Shortcut Menu

- **Main menu**

When you login, the system main menu is shown as below.



Main Menu

- **Record Control**

Please check current channel status: “○” means it is not in recording status, “●” means it is in recording status.

You can use desktop shortcut menu or click [system]> [record]> [record mode] to enter the recording control interface.



Record Mode

【Schedule】 Record according to the configuration.

【Manual】 Click the all button and the according channel is recording no matter the channel in any state.

【Stop】 Click the stop button and the according channel stops recording no matter the channel in any state.

- **Playback**

There are two methods for you to play the video files in the hard disk.

- 1、 In the desktop shortcut menu.
- 2、 Main menu>Record->Playback

Note: The hard disk that saves the video files must be set as read-write or read-only state.

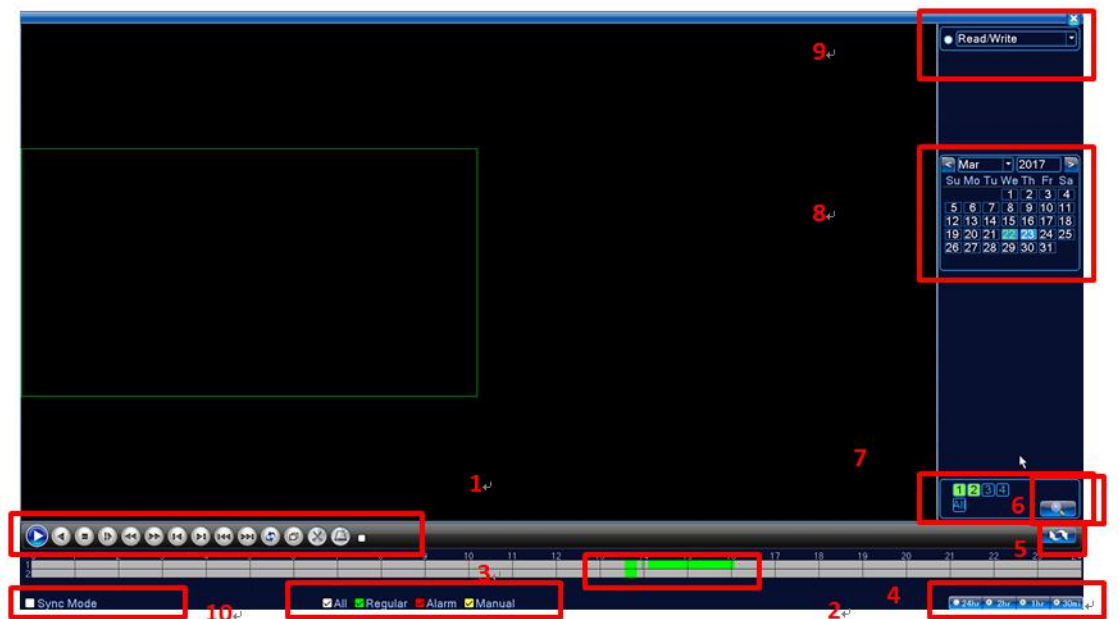















video playback

1	Playback control	2	Operation	3	Video type	4	Time display
5	Switch by time/file	6	Search the file	7	Channel selection	8	Date selection
9	HDD selection	10	Synchronous	11	Time display	12	Listed files
13	File Attributes						

【Listed files】 Look up the listed files that accord with the searching criteria.

【File Attributes】 Look up the found file information.

【Playback control】 See detail in below chart

Button	Function	Button	Function
	Play/Pause		Backward play
	Stop		Slow play
	Fast Rewind		Fast Forward
	Previous frame		Next frame
	Previous file		Next file
	Round play		Full screen
	Edit		backup

Playback control key

Note: play under frame by frame, the playback status should be paused firstly.

Special functions:

Accurate playback: Input time (h/m/s) in the time column and then click  button. The

system can operate accurate playback according to the searching time.

Local zoom: When the system is in single-window full-screen playback mode, you can drag your mouse in the screen to select a section and then left click mouse to realize local zoom. You can right click mouse to exit.

Note: When current resolution of the channel is over Max resolution, to playback this channel, will show a Red "X".

- **Alarm output**

Please check current channel status: “○” means it is not in alarming status, “●” means it is in alarming status.

You can use desktop shortcut menu or click [main menu]> [alarm]> [alarm output] to enter the alarm output interface.

***Some series have no alarm output**

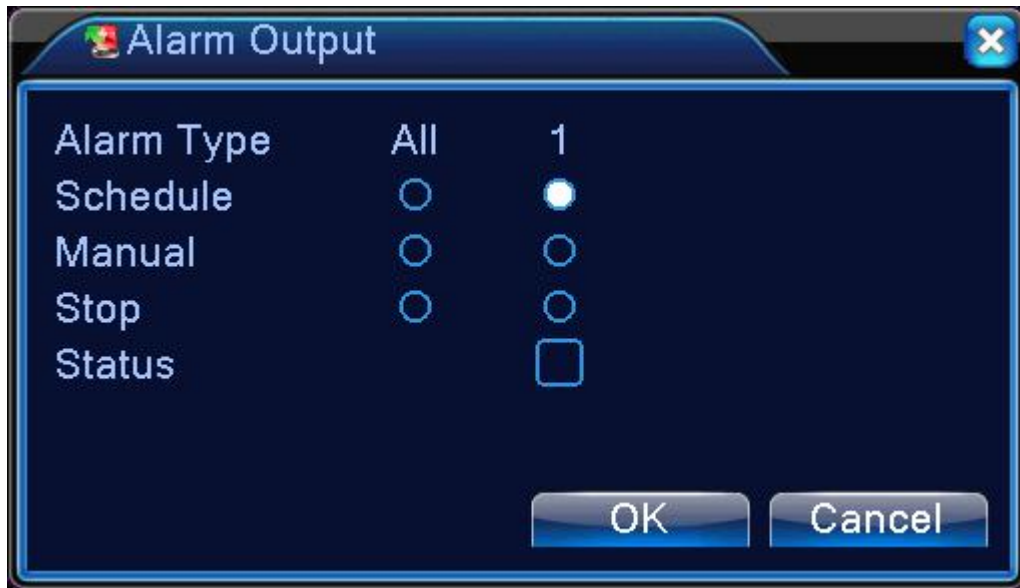

Alarm output

【Configuration】 Alarm is on according to the configuration.

【Manual】 Click the all button and the according channel is alarming no matter the channel in any state.

【Stop】 Click the stop button and the according channel stops alarming no matter the channel in any state.

- **PTZ control**

*PTZ control is a little different between hybrid mode & full digital mode:

Digital channel – the digital channel need link PTZ, the remote device should connect with PTZ and with protocol correctly set also.

Analog channel – Only when the device is connect with PTZ and configure protocol correctly is ok.

1 Operation interface is as followed. The functions include: PTZ direction control, step, zoom, focus,

iris, setup operation, patrol between spots, trail patrol, boundary scan, assistant switch, light switch, level rotation and so on.

Note1. Decoder A(B)line connects with DVR A(B)line. The connection is right.

- 2 Click [main menu] >[system configuration] >[PTZ setup] to set the PTZ parameters.
- 3 The PTZ functions are decided by the PTZ protocols.



PTZ

【Speed】 Set the PTZ rotation range. Default range: 1 ~ 8.

【Preset】 Add, delete, call preset

Add: Input preset numbers in the preset number box, and rotate the PTZ to the designated position by controlling the direction control key and then click the "+" button to complete adding;

Preset point deletion: input the preset number which you want to delete in the preset number box, click "-" button to complete the deletion of preset points;

Preset point call: fill in the preset point number in the preset number box, click on the start button to call the preset point.

【Zoom】 Click  /  button to adjust the zoom multiple of the camera.

【Hide】 Current interface will be temporarily hidden after click it.

【Direction control】 Control the PTZ rotation. 8 directions control is supportive. (4 directions in Front panel is supportive)

【High speed PTZ】 Full-screen show channel image. Left press mouse and control PTZ to rotate orientation. Left press mouse and then rotate the mouse to adjust the zoom multiple of the camera.

【Advanced】 enter the advanced PTZ settings interface, you can point to the cruise, patrol,

focus and other operations;

【Page switch】 Switch between different pages.

【Cancel】 Exit the PTZ function

1 Click [Page Switch] button, then you can set auxiliary function. Auxiliary number corresponding to auxiliary switch on the decoder.

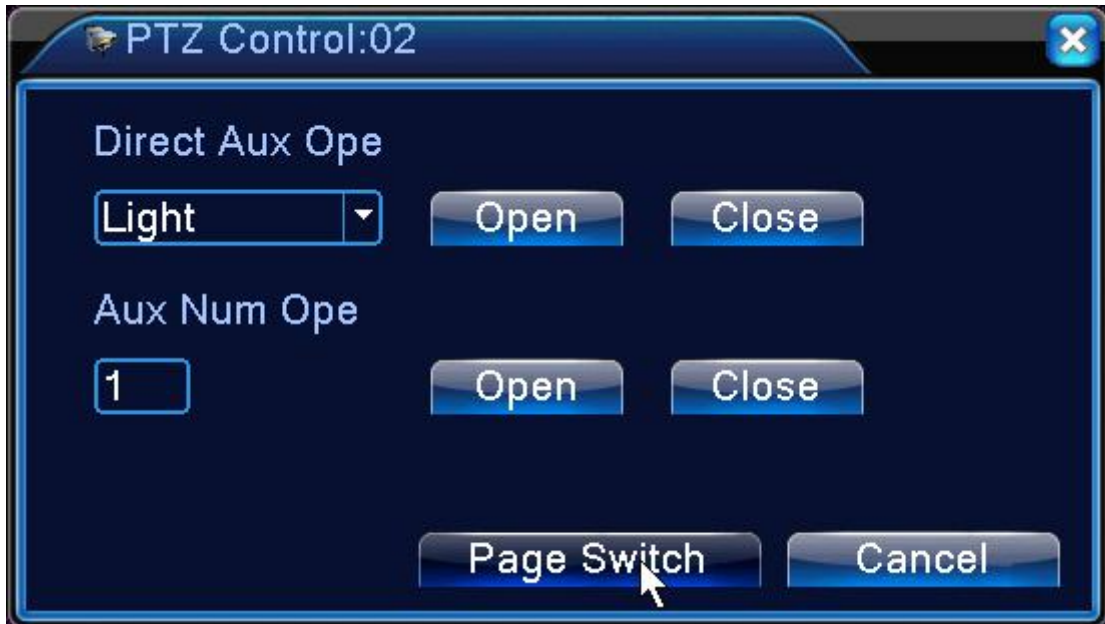

Auxiliary Function Control

【Intuitive Auxiliary Operation】 choose auxiliary equipment, select Open or Close button, switch control;

【Auxiliary Number】 The operation of corresponding auxiliary switch according to PTZ agreement;

【Page Switch】 click Page Switch button to enter the PTZ Main Menu page, the menu itself can be control by the menu control buttons



PTZ menu

2 Advanced

click on the [Advanced] button to enter a new operation page as shown below



Advanced function

【Resume】 resume the PTZ to restore default.

【Focus】 Click $-$ / $+$ button to adjust the focus of the camera (require the camera support auto focus).

【Iris】 Click $-$ / $+$ button to adjust the iris of the camera (require the camera support aperture).

【Tour】 Add a plurality of preset points to set a cruise line and call the cruise line, then the pan will run on the cruise line.

For the first time to add a cruise route, click the “+” button to enter the cruise route:



Tour

In the preset drop-down box, select the preset point that needs to be added to the cruise route, set the interval time (between 3-255 seconds), and then click the “add preset” button to complete the preset point.

Click the “start” button to call the selected preset point, click “del preset” you can delete the preset point in the cruise line; check the drop-down menu you can view the current cruise line has been added to the preset point number.

【Pattern】: Control the pan movement, the back-end device will record the running track of the pan, and then call the trail, pan will be repeated in accordance with the recorded track. When you first add the trace, click on the “+” button to enter the track settings page:.



Pattern

You can control pan movement by the PTZ key, zoom, focus and aperture ,then click “OK” to finish

【Autoscan】 Set the two boundaries in the horizontal direction of the left and right sides and then call the scan,the pan will run between the left and right boundaries in the horizontal direction.

Click on the“left” button and then control the pan tilt using the horizontal arrow keys. when it arrive the position then click "right"button to finish the setting.Click the “Autoscan” button to call the scan,click the stop button to stop calling.

【AutoPan】 Click on the ?AutoPan? button, the pan will rotate (relative to the original position of the camera for horizontal rotation). Click the stop button to stop the AutoPan

【Flip】 click on the ?Flip?button, the pan will start to flip.

【Reset】 the pan will restart,and all the data will be restored default.

- **Coaxial control**

The coaxial control function allows the video recorder to transmit the control signal to the front-end camera through the coaxial cable. using these control signals, the recorder can control the PTZ, menu and other functions of the front camera.

Note: it require the front-end camera also support this function



Coaxial control

【1 channel selection】 select the channel by clicking the drop-down menu;

【2 adjust the front-end camera's parameter】 adjust the parameters of the front-en camera by dragging the mouse or check the function;

【3 ok 】 enter OSD menu or ok function

【4 Direction key】 Control the OSD menu by four key;

- **Color setting**

***Color config:analog channel can config its own color,digital channel can config front-end image(only NETIP-conformed device is supported,ONVIF-conformed device is not supported)**

Set the selective image parameters (current channel for single window display and cursor place for multi-window display). You can use the desktop shortcut menu and enter the interface. The image parameters include: tonality, brightness, contrast, saturation. You can set different parameters at different time sections.



Color Setting

- **Output Adjust**

***Hybrid mode is with black margin vertical & horizontal, while full digital mode without.**

Adjust TV output area parameters. You can use the desktop shortcut menu or enter [main menu]> [management tools]> [Output adjust].



Output Adjust

Note: The black margin vertical & horizontal at output adjust of hybrid mode is only effect to analog channel.

- **Logout**

Logout, shut down the system or reboot up. You can use the desktop shortcut menu or enter [main menu].



Picture 3.17 Logout/Shutdown/Reboot the system

【logout】 Quit the menu. Offer password next entrance.

【shut down】 Quit the system. Turn off the power supply.

When press the shut down button, there is schedule hint. After three seconds, the system is shut down. Cancel midway is of no effect.

【reboot】 Quit the system. Reboot up the system.

- **Window switch**

Preview in single window/four windows/eight windows/nine windows/sixteen windows according to your choice.

Note: different video input number have different switchable preview picture.

- **Quick-set**

Only network channel has quick-set function ,you can quickly add a remote device to the network channel.

Click on the "+" sign in the preview screen, pop up the digital channel configuration wizard page, add the remote device to the DVR/NVR network channel.

- **IP parameter**

This function is only available in all digital and hybrid channel modes and it is used to set the remote IPC camera parameters, the gray character indicates that the remote device does not support this function. You can adjust the various front-end parameters of the connected IPC, such as exposure mode, day / night mode, image style, day and night switching threshold, AE sensitivity, AGC, WDR, de-fog, corridor (some models support this function), slow shutter, day / night noise level, mirror, anti-flicker, flip, IR swap and so on.

Note: Only when the NVR successfully connected to the company's IPC (using NETIP protocol) and in a single connection can support the function, if you connected to third-party IPC (using ONVIF protocol) can't support this function.

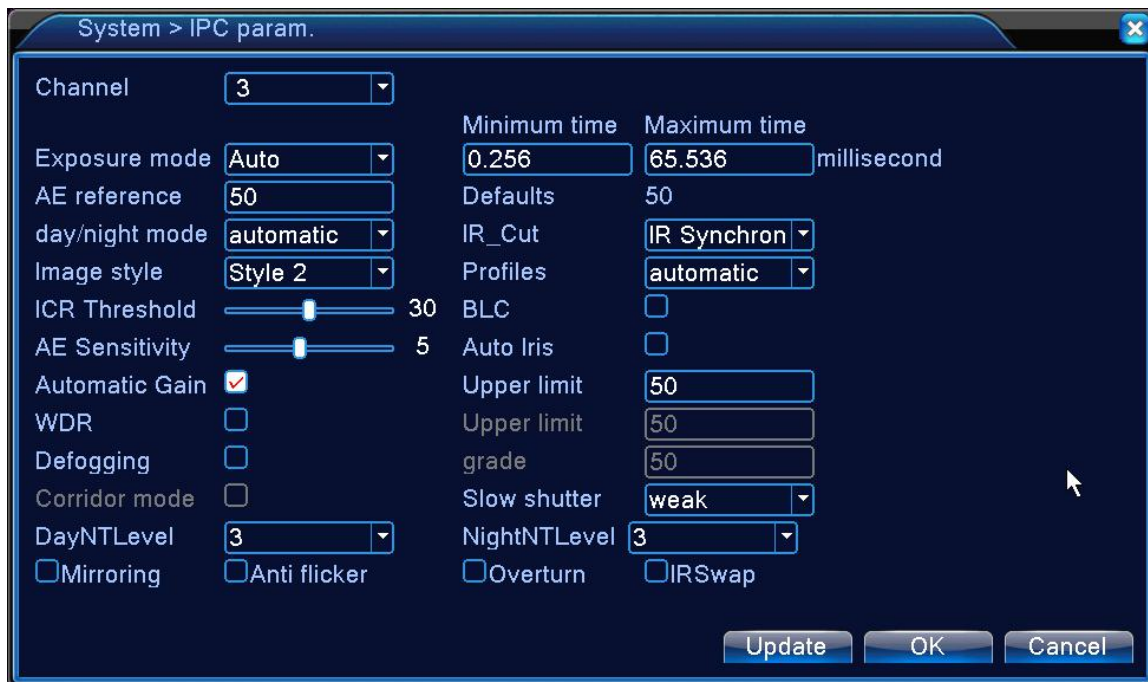

【Exposure mode】 You can set the exposure time ,choose auto or manual from 1/50 to1/1000S,the exposure time more longer, the image more brighter.

【Day/Night mode】 You can modify the camera Day/Night mode manually.:

Auto: the image can be color or B&W depending on the light;

Color: the image will always be color;

Black and White: the image will always be color;

【BLC】 can close/open this function, when you open BLC(Black Light Compensation), In the bright background environment ,it is still able to see the central scene of the main scene.

【Auto Iris】 can close/open this function, This feature requires the camera to mount a lens that supports auto iris.

【Profiles】 there are three mode:AUTO、 Indoor、 Outdoor

【AE Reference】 set the camera's exposureSet the camera exposure, between 0 to 100 optional, the greater the reference value of the screen ,the more bright.

【ICR Threshold】 it is relate to IRCUT swap mode:

IR_CUT automatically switch: the critical point for color and black/ white switching, the Day/Night conversion threshold greater ,the higher brightness from color to black.

IR_CUT IR synchronous switch: Day/Night conversion threshold 10-20 close anti-shake function, 21-30 anti-shake time is 3S, 31-40 anti-shake time is 4S, 41-50 anti-shake time is 5S.

【AE Sensitivity】 . The higher the sensitivity, the switch will be faster.

【AGC】 can close/open this function, when you open this function, it can automatically adjust the camera's sensitivity to adjust the image brightness according to the ambient light changes

【WDR】 can close/open this function, when you open this function, it can adjust the ?Upper limit?to see the main scene in the center of the screen clearly in the strong light background.

【Defogging】 can close/open this function, when open this function, The picture permeability can be improved in fog or haze weather, the higher the lever is ,the better the defogging effect

【Corridor mode】can close/open this function, when open this function, When the corridor mode is on, the camera screen will display in corridor mode (Only some models can support this function)。

【Slow Shutter】there are four choose :none、 low 、 medium、 high.The brightness is increased by the frame accumulation, and extend the exposure time to enhance the image sensitivity at low illumination.

【IR_CUT】 can be set as automatically switch or IR synchronous switch

automatically switch: swap ICUT according to the actual environment ;

IR synchronous switch: swap ICUT according to the IR lamp status ;

【DayNTLevel】 When the light is sufficient, the level to eliminate the noise in the preview screen, the higher the level the better the noise reduction effect.

【NightNTLevel】 When the light is insufficient, the level to eliminate the noise in the preview screen, the higher the level the better the noise reduction effect.

【Mirror】: Enable it ,the preview screen flip 90° left and right

【Flip】: Enable it ,the preview screen flip 90° up and down

【Anti-flicker】: Remove the horizontal scroll stripes in the preview screen in the fluorescent environment.

【IR Swap】: use when the ir_cut in reverse order.

- **AHD&TVI&CVI Signal Switch**

This function is supported by only part of the models with analog channel, it can control the signal mode of each channel. You can right-click to enter the shortcut menu, Or you can double-click the icon  in the bottom left corner of the channel, then you can switch the AHD&TVI&CVI Signal you can also directly through the left mouse button double-click the channel at the bottom of the signal switch icon to achieve the signal AHD & TVI & CVI signal switching.

4 Main menu

- **Main menu navigation**

Main menu	Sub menu	Function
Record	Config	Set the recording configuration, recording type, recording time section
	playback	Set recording search, recording play, video file storage
	backup	Detect backup device, format device, back the selective files
Alarm	Motion detection	Set motion detect alarm channel, sensitivity, area, linkage parameters: defending time section, alarm output, screen hint, recording, screen shot, PTZ, patrol, buzz, email , PMS and FTP upload
	Video blind	Set camera mask alarm channel, sensitivity, linkage parameters: defending time section, alarm output, screen hint, recording, screen shot , PTZ, patrol, buzz, email , PMS and FTP upload
	Video loss	Set video loss alarm channel, linkage parameters: defending time section, alarm output, screen hint, recording, screen shot , PTZ, patrol, buzz, email , PMS and FTP upload
	Alarm input	Set alarm input channel, equipment type, linkage parameters: defending time section, alarm output, screen hint, recording, screen shot , PTZ, patrol, buzz, email , PMS and FTP upload Note: part of models not support this function
	Alarm output	Set alarm mode: configuration, manual, shut down Note: part of models not support this function
	Abnormality	No HDD, HDD error, HDD capacity not enough, network cut, IP Conflict, linkage parameters, screen hint or buzz.
	Intelligent	Set algorithm rule: Perimeter alert 、 Items care、 Video Diagnosis setting linkage parameters :show traces、 sensitivity、 minimum moving distance、 alert way、 Linkage parameter: period、 alarm output、 the screen prompt、 record、 PTZ、 tour、 buzzer、 EMAIL、 FTP upload. Note: part of models not support this function

System Configuration	General	Set system time, data format, language, hard disk full time operation, machine number, video format, output mode, summertime, stay time
	Encode	Set main (extra) coding parameter: code mode, resolving ability, frame rate, code stream control, image quality type, code stream value, frame between value, video/audio enable, Note : only Hybrid mode and full analog mode have encode configuration.
	Network	Set basic network parameters, DHCP and DNS parameters, network high speed download
	Net Service	PPPOE、NTP、Email、IP purview、DDNS parameter、PMS
	Display	Set channel title, preview hint icon state, transparency, cover area, time title, channel title fold. Note : only analog channel can set channel name,region cover ,time title,channel title fold.
	PTZ configuration	Set channel, PTZ protocol, address, baud rate, date bit, stop bit, check Note: Hybrid mode shows PTZ configuration,T series have no this function.
	RS485 Device	Set serial port function, baud rate, date bit, stop bit, check Note: Full digital mode shows : RS485 Device
	RS232	Set serial port function, baud rate, date bit, stop bit, check Note: part of models not support this function
	Tour	Set patrol mode and interval time
	Digital	Set channel mode, check channel status and configure the digital channel, etc. Note: part of series support this
	IPC Param	Set the front-end IPC parameters such as exposure mode, day / night mode, profile, Note: The front end of the ONVIF connection is not supported

Management tools	Storage	Set appointed hard disk as read-write disc, read-only disc or redundant disc, clear data, resume date and so on
	Account	Modify user, team or password. Add user or team. Delete user or team.
	Online user	Break the connection with the already login user. Lock the account after break until booting up again.
	Output adjust	Adjust upside, downside, nearside, starboard distance, black margin vertical & horizontal Note: only analog channel have black margin vertical & horizontal
	Automatic maintenance	Set automatic reboot system and automatic deleting files.
	Restore	Resume setup state: common setup, code setup, recording setup, alarm setup, network setup, network service, preview playback, serial port setup, user management
	Upgrade	upgrade with external device(like USB)
	Device Info	device hardware configuration and message
	Import/Export	Export the device's log or configuration to external device(like USB flash disk);Input the configuration with external device(like USB flash disk).
System information	HDD info	Display hard disk capability and recording time
	BPS	Display code stream information
	Log	Clear all log information according to the log video and time
	Version	Display edition information
Logout	Logout	Logout, shut down or reboot

- **Record**

Operations related to record, including: Record, Playback, Backup, Screen shot(only Hybrid mode and full analog have)

4.2.1 Record Configuration

Set the recording parameters in the surveillance channel. The system is set 24 hours consecutive recording in the first startup. You can enter [system]> [record]> [record conf.] to set.

Note:There is at least one read-write hard disk.



Record Configuration

【Channel】 Choose the corresponding channel number to set the channel. Choose the all option to set the entire channels.

【Redundancy】 Choose the redundancy function option to implement the file double backup function. Double backup is writing the video files in two hard disks. When you do the double backup, make sure that there are two hard disks installed. One is read-write disk and the other is redundant disk.

【Length】 Set the time length of each video file. 60minutes is default value.

【Pre-Record】 Record 1-30 seconds before the action. (time length is decided by the code stream)

【Record mode】 Set video state: schedule, manual or stop.

Schedule:Record according to the set video type (common, detection and alarm)and time section.

Manual:Click the button and the according channel is recording no matter the channel in any state.

Stop:Click the stop button and the according channel stops recording no matter the channel in any state.

【Period】 Set the time section of common recording, The recording will start only in the set range.

【Record type】 Set recording type: regular, detection or alarm.

Regular:Perform the regular recording in the set time section. The video file type is “R”.

Detection:Trigger the “motion detect”, “camera mask” or “video loss” signal. When above alarm is set as opening recording, the “detection recording” state is on. The video file type is “M”.

Alarm:Trigger the external alarm signal in the set time section. When above alarm is set as opening recording, the “detection recording” state is on. The video file type is “A”.

4.2.2Playback

Refer to chapter 3.6.3.

4.2.3Backup

You can backup the video files to external storage through setup.

Note: The storage must be installed before the file backup. If the backup is terminated, the already backup can playback individually.

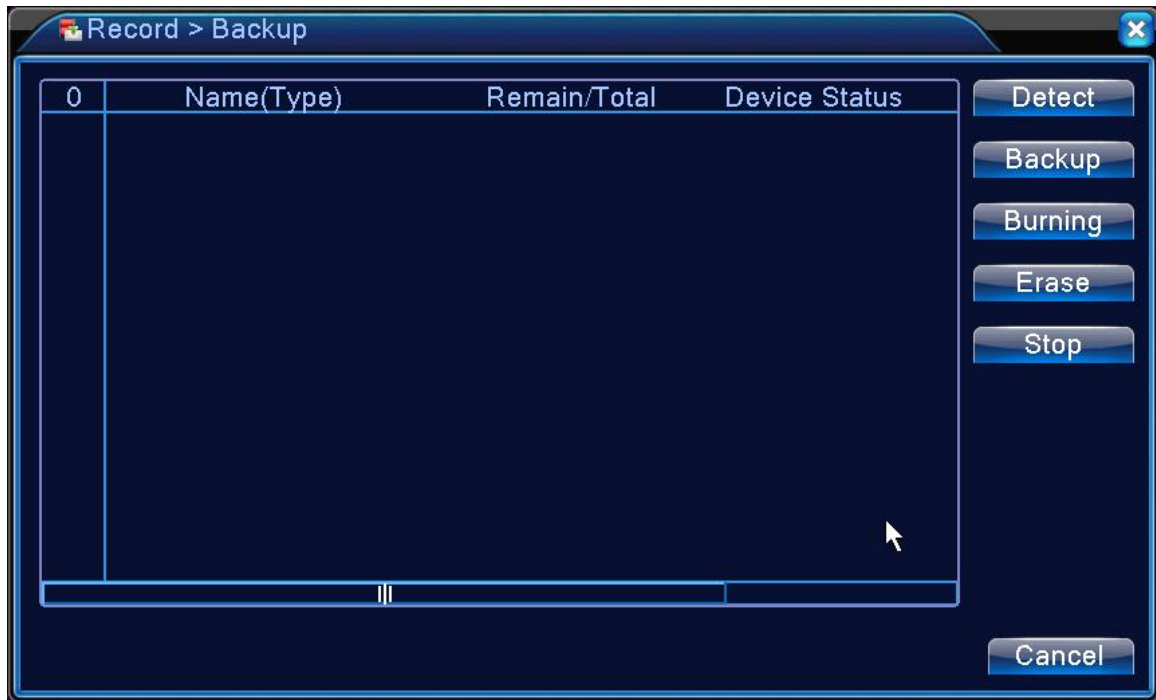

Backup

【Detect】 Detect the storage connected with the DVR such as hard disk or universal disk.

【Backup】 Click backup button and the dialog box is popped up. You can choose the backup file according to the type, channel and time.

【Burning】 the file will be burned synchronously after click it.

【Erase】 Choose the file to delete and click erasure to delete the file.

【Stop】 Stop the backup.

- **Alarm Function**

Alarm functions include: motion detect, video blind, video loss, alarm input and alarm output, abnormality, intelligent analysis.

- **Motion Detect**

When system detects the motion signal that reaches the set sensitivity, the motion detect alarm is on and the linkage function is turned on.

Note: "Advanced" button is the same as right click.

***Motion detect function is different between Hybrid mode & Full digital mode:**

Digital channel: not only to enable motion detect function at local side, but also to enable the remote device that was connected. when remote device detect motion movement, local side will start alarm recording, otherwise this function is not enable.

Hybrid mode: only need to enable motion detect function at local side.

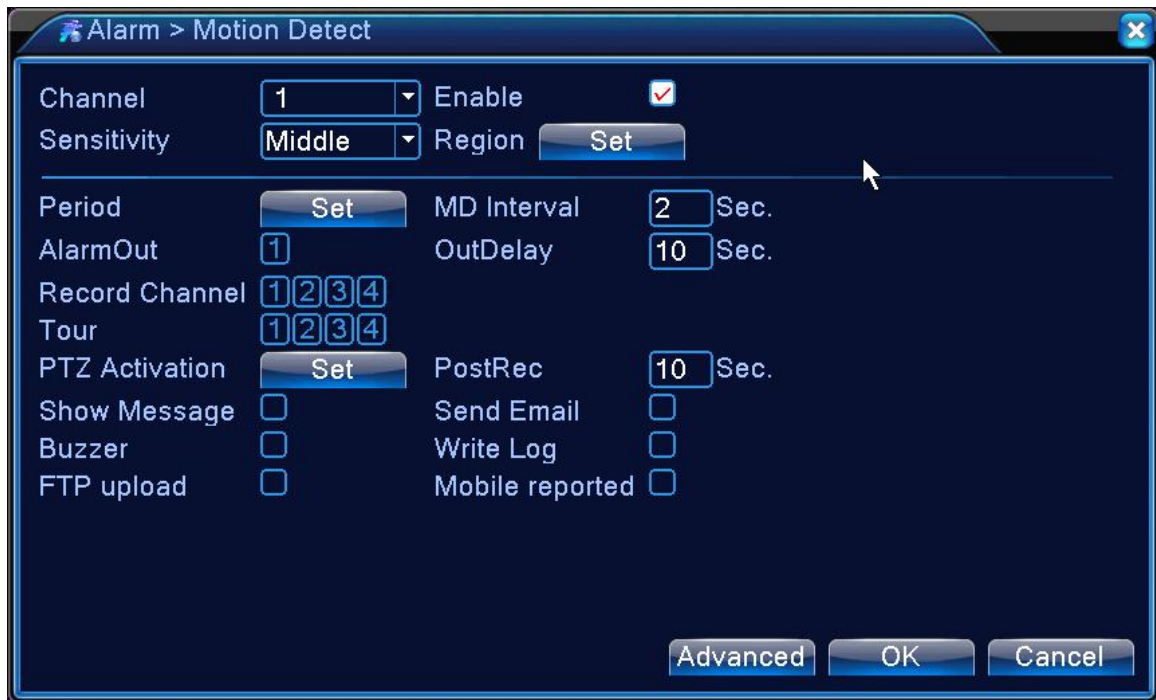

Motion Detection

【Channel】 Choose the set motion detect channel.

【Enable】 ■ means that the motion detect function is on.

【Sensitivity】 Choose in the six options according to the sensitivity,Lowest,Lower,Middle,High,Higher and Highest.

Note: Only the motion detect under hybrid mode/ full analog mode have this function of setting sensitivity, and also only the analog channel can set region.

【Region】 Click [set] to enter the set area. The area is divided into PAL22X18. Red block means the motion detect defensive area. White block means the unfenced area. You can set the area as followed, Drag the mouse and draw the area. Default: all selected blocks are detection area.

Note: Only the motion detect under hybrid mode/full analog mode have this function of setting region, and also only the analog channel can set region.

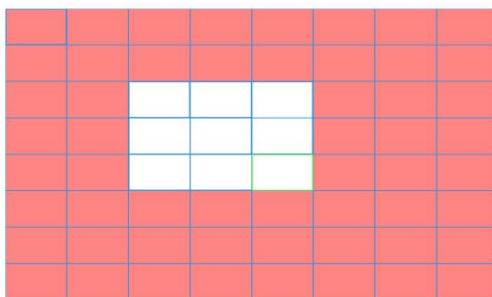

Region

【Period】 Trigger the motion detect signal in the set time section. You can set according to week or set uniformly. Each day is divided into four time sections.■ means the set valid.

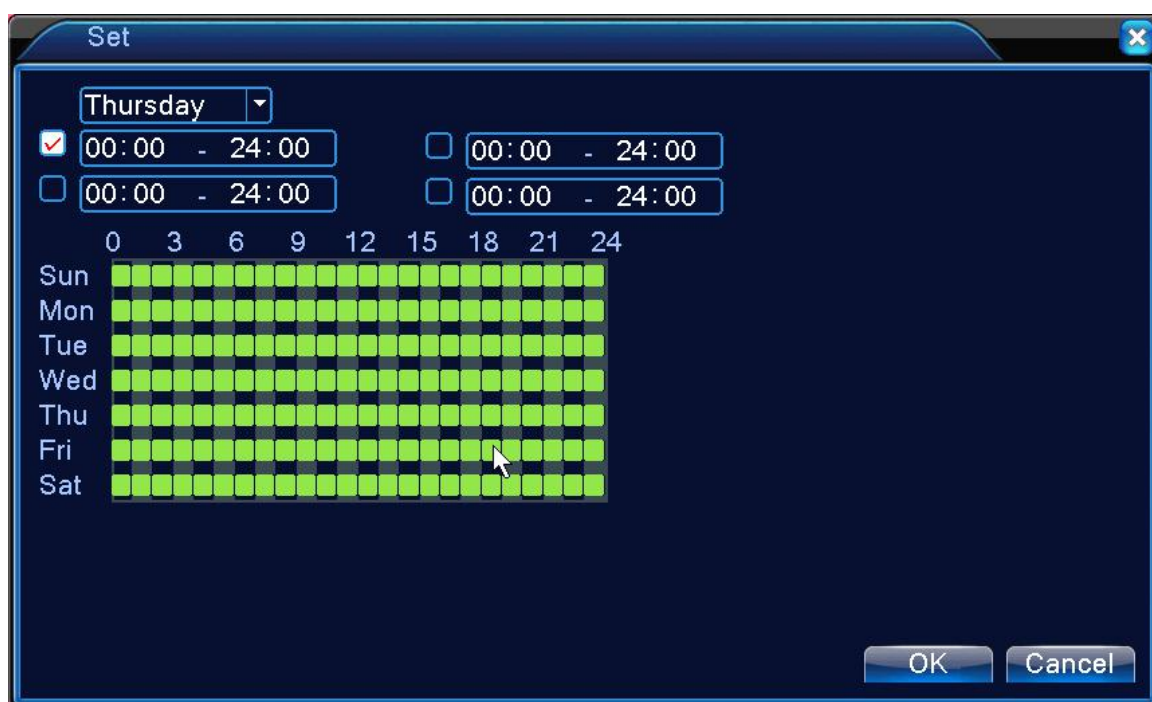

set the time section

【Interval】 Only one alarm signal is turned on even there are several motion detect signals in the set interval.

【Alarm output】 Start the external equipment of corresponding linkage alarm when the motion detect alarm is turned on.

【OutDelay】 Delay a few moments and stop when the alarm state is turned off. The range is 10~300 seconds.

【Record channel】 Choose the recording channel (multiple option supportive). Trigger the video signal when the alarm is turned on.

Note: Set in the [recording setup] and perform the linkage recording. Start detecting video files

in the corresponding time section.

【Tour】 ■ means that the selective channel is single window alternate patrol preview. The interval is set in the [Main Menu]>[System] > [Tour].

【PTZ Activation】 Set the PTZ activation when the alarm is turned on.

***Hybrid mode, PTZ link to the related PTZ information of analog channel, While digital channel model, the PTZ is link to the related PTZ information on the remote device connected.**

Note: to link PTZ, need go [Shortcut menu]->[PTZ control] to set preset point, cruise between points & interval time, etc.



PTZ Activation under hybrid mode

【PostRec】 When alarm is over, recording will last some seconds(10~300sec), then stop.

【Show message】 Pop the alarm information dialog box in the local host computer screen.

【Send EMAIL】 ■ means sending an email to user when the alarm is turned on.

Note: Set in the [NetService] and send email.

【FTP upload】 to tick it, the video & picture of related record channel & snapshot channel will be uploaded to assigned position.

Note: FTP upload need be set at [NetService]

【Buzzer】 When alarm happens, device will come out with buzzer.

【Write Log】 when an alarm occurs, the device write a log which you can check on the [Info]>[Log].

【Mobile reported】 when alarm happens, the alarm information will be push to your mobile client.

Note: Before use this function, you need to enable the PMS or mobile report in [main menu] > [system] > [NetService]. And you should install our APP and add the DVR to the APP.

- **Video Blind**

When the video image is influenced by the environment such as bad brightness or reaching the set sensitivity parameter, the camera mask function is turned on and the linkage function is turned on.

***Same as motion detect function, video blind is different between Hybrid mode & Full digital mode:**

Digital channel: not only to enable video blind function at local side, but also to enable the remote device that was connected. When remote device with video blind, local side will start alarm recording, otherwise this function is not enable.

Hybrid mode: only need to enable video loss function at local side.

Note: "Advanced" button is the same as right click.

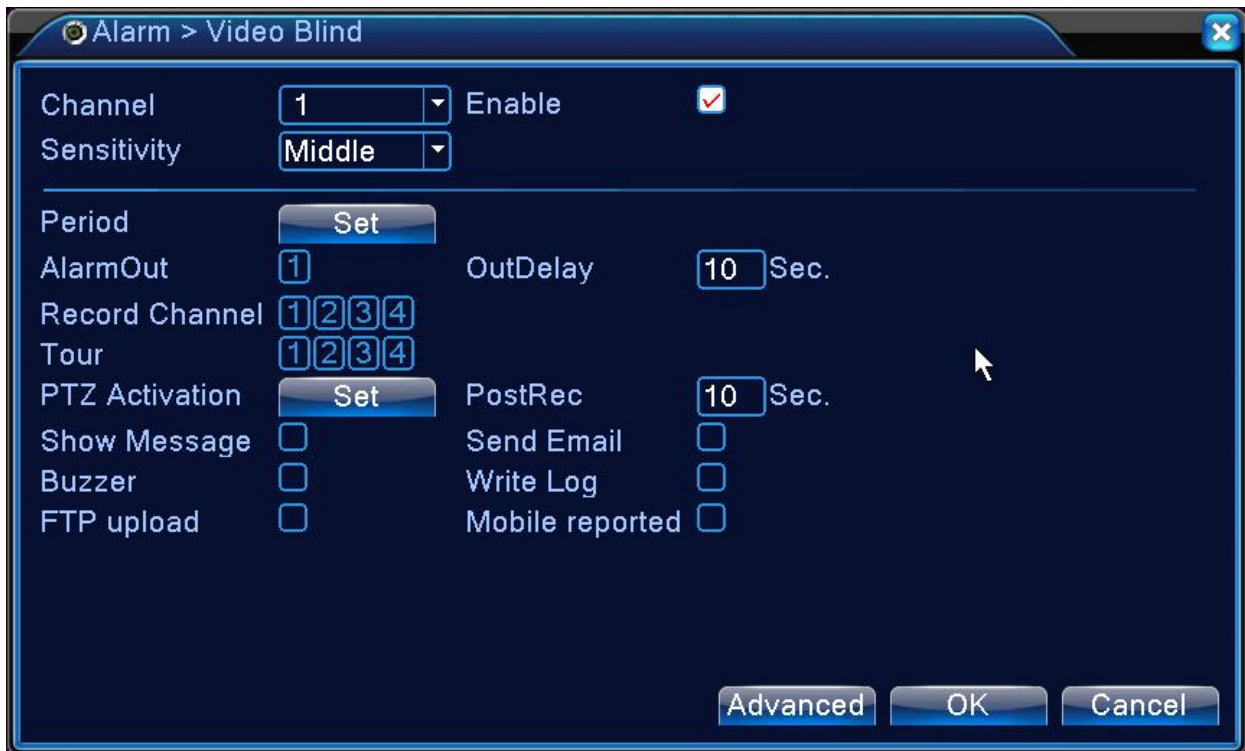

Video blind

Set method: refer to chapter 4.3.1. Motion detect

- **Video Loss**

When the equipment can not obtain the channel video signal, the video loss alarm is turned on and the linkage function is turned on.

***Same as motion detect function, video loss is different between Hybrid mode & Full digital mode:**

Digital channel: not only to enable video loss function at local side, but also to enable the remote device that was connected. when remote device with video loss, local side will start alarm recording, otherwise this function is not enable.

Hybrid mode: only need to enable video loss function at local side.

Note: "Advanced" button is the same as right click.

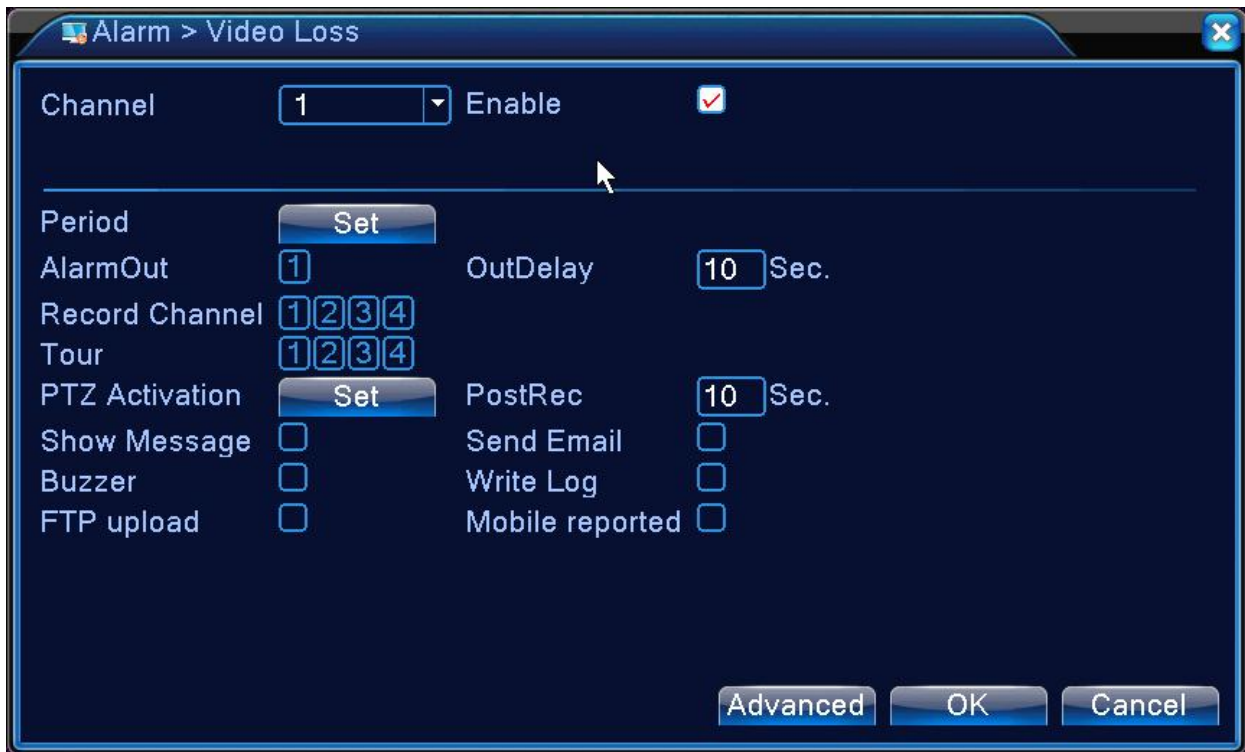

Video loss

Set method: refer to chapter 4.3.1. Motion detect

- **Alarm input**

When the equipment obtains the external alarm signal, the alarm function is turned on.

***Alarm input is the same between hybrid mode & full digital mode, function enable, when it was set normal, only need to connect alarm sensor at alarm input port on local side, the alarm information is occurring, and will link to related setting functions at the same time**

Note: "Advanced" button is the same as right click.

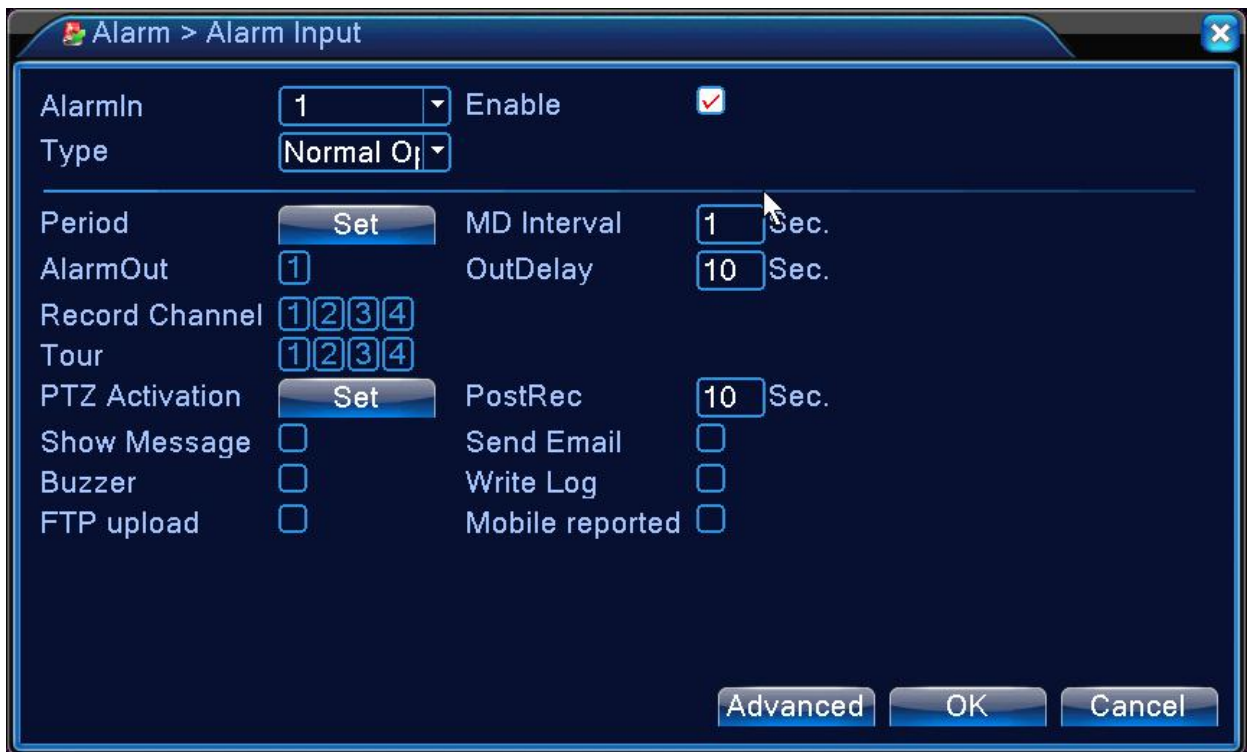

Alarm input

Set method: refer to chapter 4.3.1. Motion detect

- **Alarm output**

Refer to chapter 3.6.4.

- **Abnormal**

Analysing and inspecting current software and hardware of the device: When some abnormal events happen, the device will make a relative answer such as show message and buzzer.

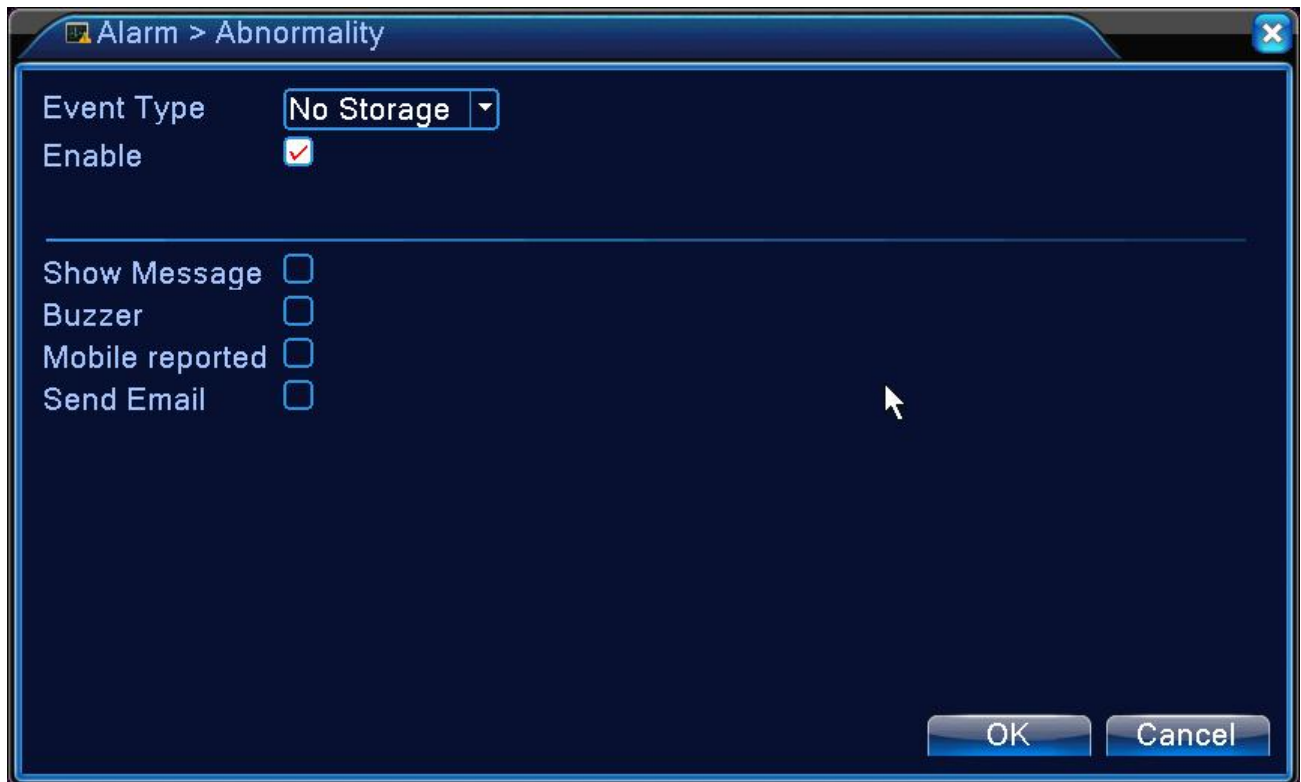

Abnormal

【Event Type】 selecting abnormality you want to inspect. There are No Storage, Storage Error, Storage No Space, Net Disconnection and IP Conflict.

【Enable】 Select it to make sure abnormal function workable

【Show message】 Automatically alarm cue dialog box come out of the main screen

【Buzzer】 Device will have one long nosie ?di? while alarm is happening

【Mobile reported】 When alarm happens, it will send an email to user.

【Send Email】 When alarm happens, the alarm information will be push to your mobile client.

- **Intelligent analysis**

***Note: only part of product support this function at present.**

To analyze the video image, when system detect object that meet pre-set algorithm rules and fit set flexibility and minimum image distance, will trigger video analysis alarm, and enable the linkage function.

***only the 1st channel of full analog mode and hybrid mode can support this function, and if this function is enabled, then video blind is invalid.**

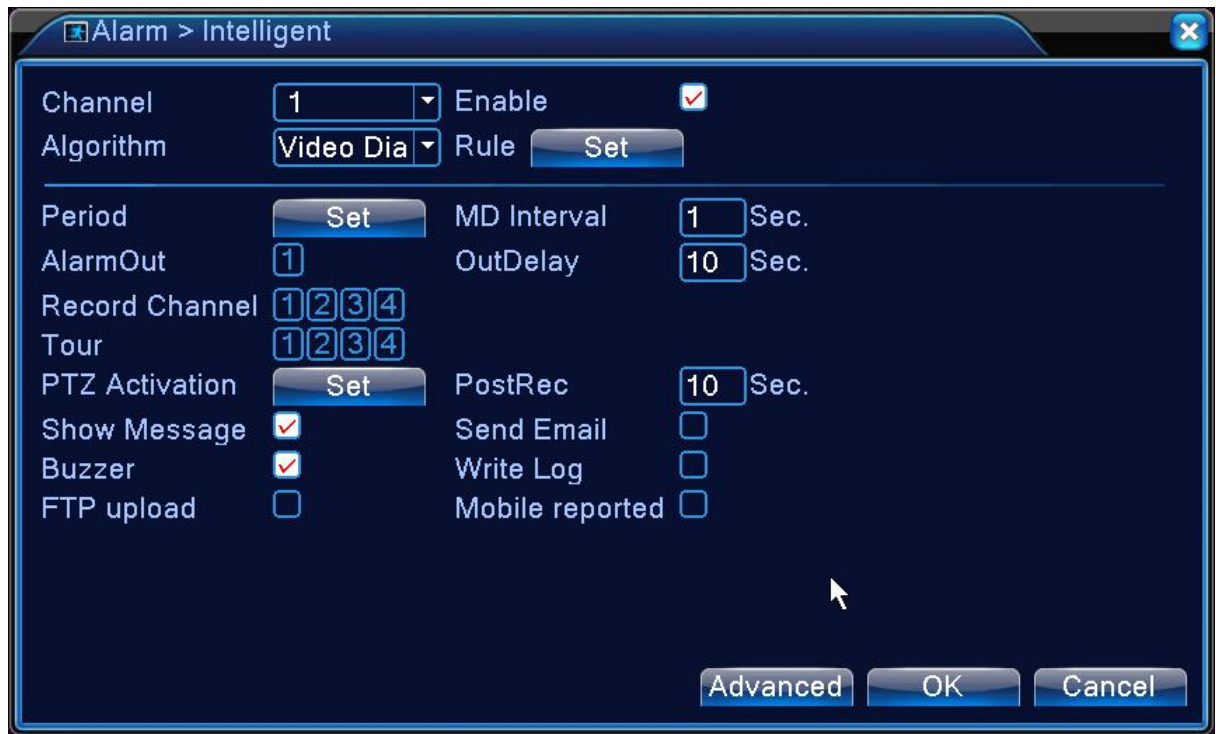

Intelligent analysis setting page

【Channel】only shows by ?1?, at present, only the 1st channel with maximum resolution of 1080P in the full analog(DVR) mode and hybrid(HVR) mode

【Enable】 tick it to enable the video analysis function, then can go for further setting,

【Algorithm】at drop-down box, Perimeter alert, Items care and Video Diagnosis to choose the algorithm rule of detection,

【Rule】 choose different algorithm rules, the related setting page is different.

Perimeter alert:

- 1 **Show traces:** tick it to enable, when alarm triggers, there will be red box around moving objects.;
- 2 **Sensitivity** , base on different requirement, there are 3 options in the drop-down box,Higher,Middle and Lower;
- 3 **Minimum image distance** range between 0~30 % . the more flexible the less image distance.;
- 4 **Alert way** there are 2 kinds: cordon and warning area. **Cordon:** Can set 3 prohibited directions: bidirectional prohibited, from top to bottom (from left to right), from bottom to top (from right to left), when the setting cordon is too slope, show with from left to right / from right to left, otherwise will be from top to bottom / from bottom to top, when the moving object meet preset cordon rules, the alarm will be triggered; **Warning area:** can set 3 kinds of prohibited directions: bidirectional prohibited, enter and leave, when the moving object meet preset warning area rules, alarm will be triggered.

- 5 **Rule** click **set**, enter rule setting page, right click mouse, choose add, use mouse to fix two or more point, and then connect them to form a line or a irregular region, after that a box of prohibited direction options will come out, choose one of them, right click mouse, click Yes, return to previous page, click Yes, alarm rules setting is finished.

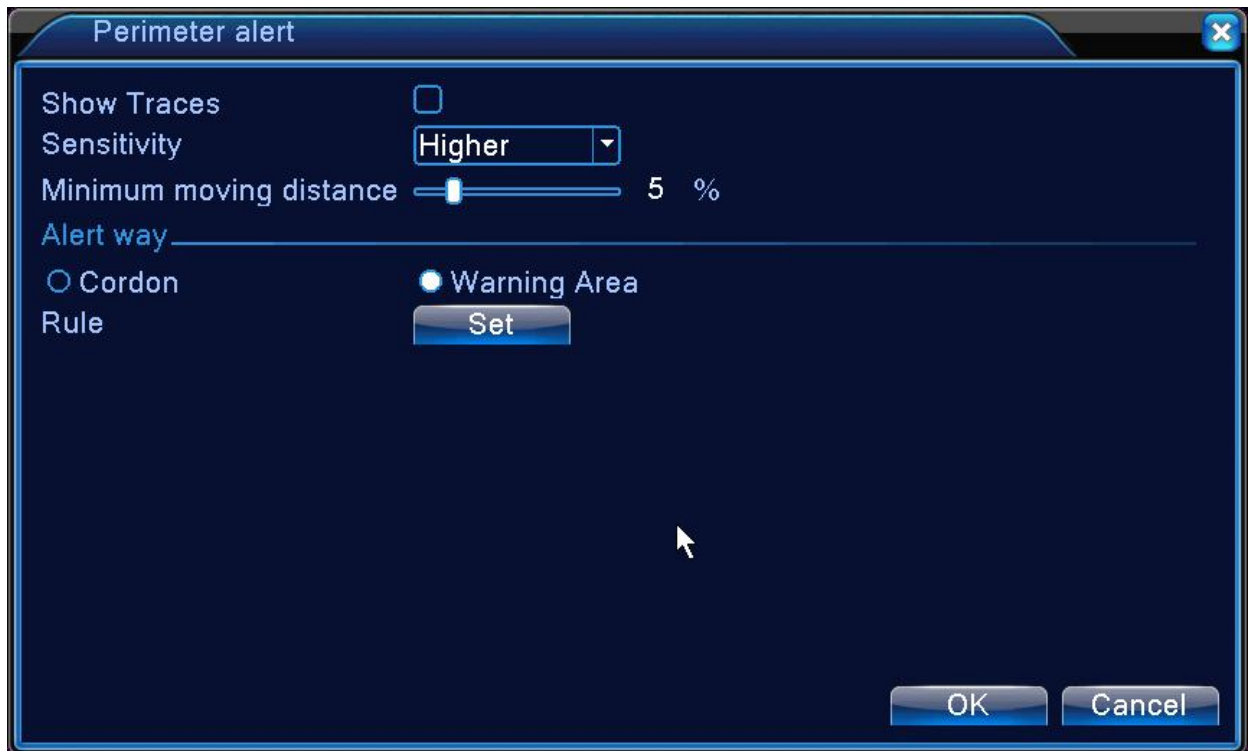

Rule setting – Perimeter alert

Items care:

- 6 **Show traces** tick it to enable, when this function is triggered, there will be read box shows around the moving object
- 7 **Sensitivity:** base on different requirement, there are 3 options in the drop-down box Higher,Middle and Lower.
- 8 **Minimum image distance:** range between 0~30 %, the more flexible the less image distance.
- 9 **Alert way:** three modes: Items stranded、Items stolen、Illegal parking.Items stranded:object appears within warning area, and the size of object meet the rules of minimum image distance, alarm will be triggered. Items stolen:object disappears within warning area, and the size of object meet the rules of minimum image distance, alarm will be triggered; Illegal parking:this way is similar with Items stranded.
- 10 **Rule:** click **set**,enter the setting page of rule, right click mouse, choose add, use mouse to fix several

points and then connect them to form a irregular region, right click mouse, click Yes, return to previous page, click Yes, alarm rule setting if finished.

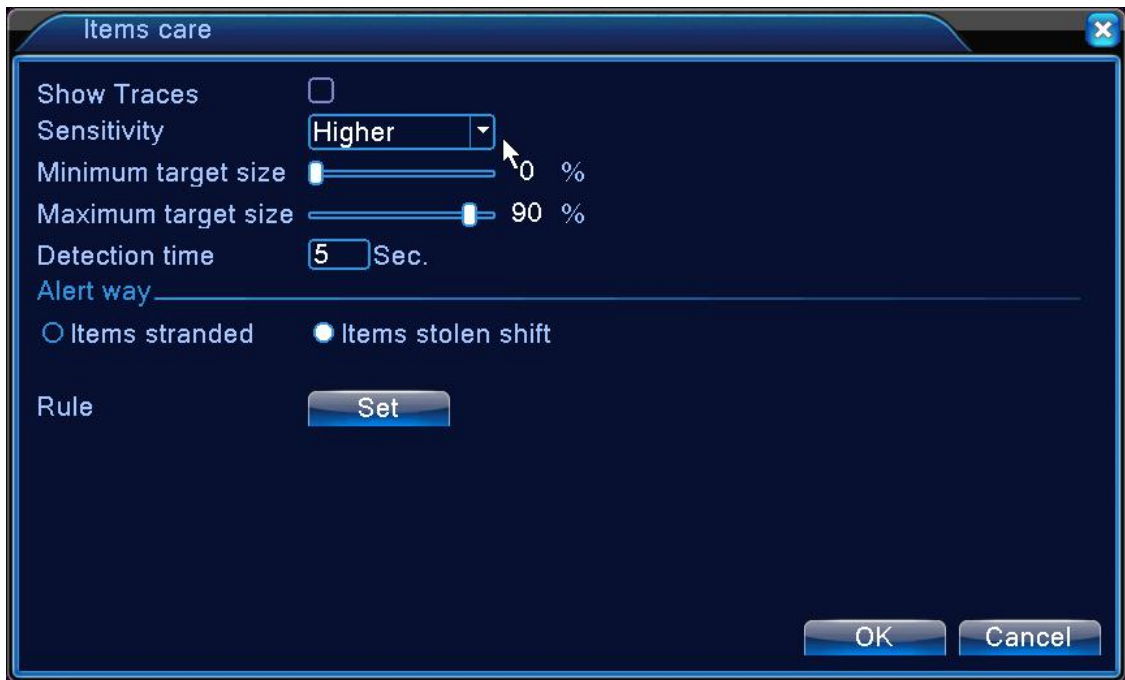

Rule setting - items care

Video diagnosis:

- 11 **Sensitivity** , base on different requirement, there are 3 options in the drop-down box Higher,Middle and Lower;
- 12 **Detection type:** there are 8 kinds of detection type: Brightness anomaly detection、Sharpness detection、Noise detection、Color cast detection、Screen freezes detection、Scene change detection、Anthropogenic interference and PTZ runaway detection. You can choose one or more types if necessary, when video detect selected type, the alarm will be triggered. Now, only support “Scene change detection”.

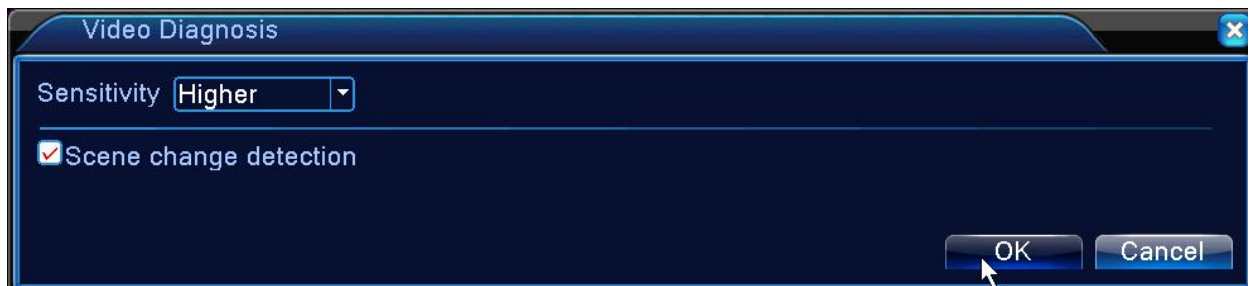

Rule setting - video diagnosis

The setting way of set / withdraw garrison time period and linkage parameter, please refer to chapter“4.3.1 motion detection”

For example: enable video analysis function, algorithm rules is **Perimeter alert**, the alert way in the rule is **Cordon**, prohibited direction is bidirectional, when a moving object across this warning line, alarm is triggered, see below picture

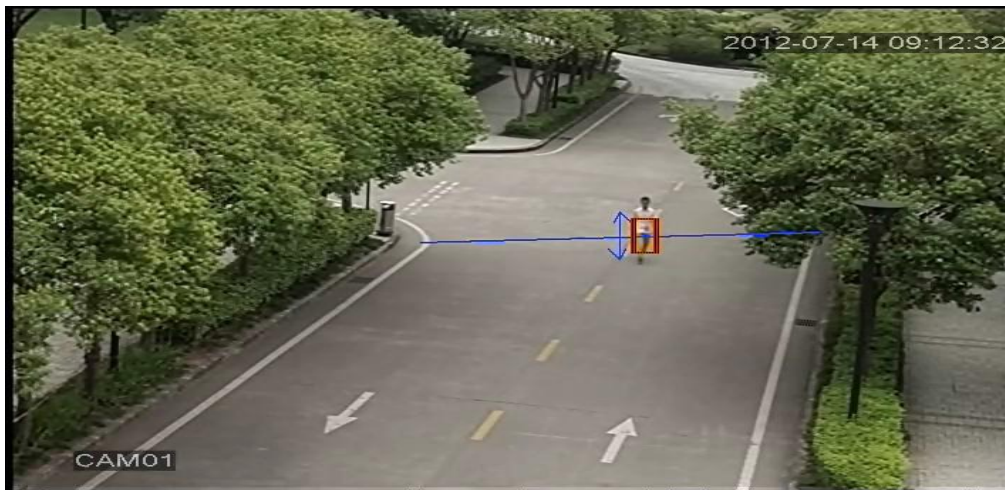

The alarm image regarding one of the video analysis

- **System setup**

Set the system parameters such as **General**, **Encode**(under Hybrid/full analog mode)、**Network**, **Net service**、**GUI display**、**PTZ configure/RS485 device**、**RS232**、**Tour setup**、**Digital and IPC param.** .

- **General**

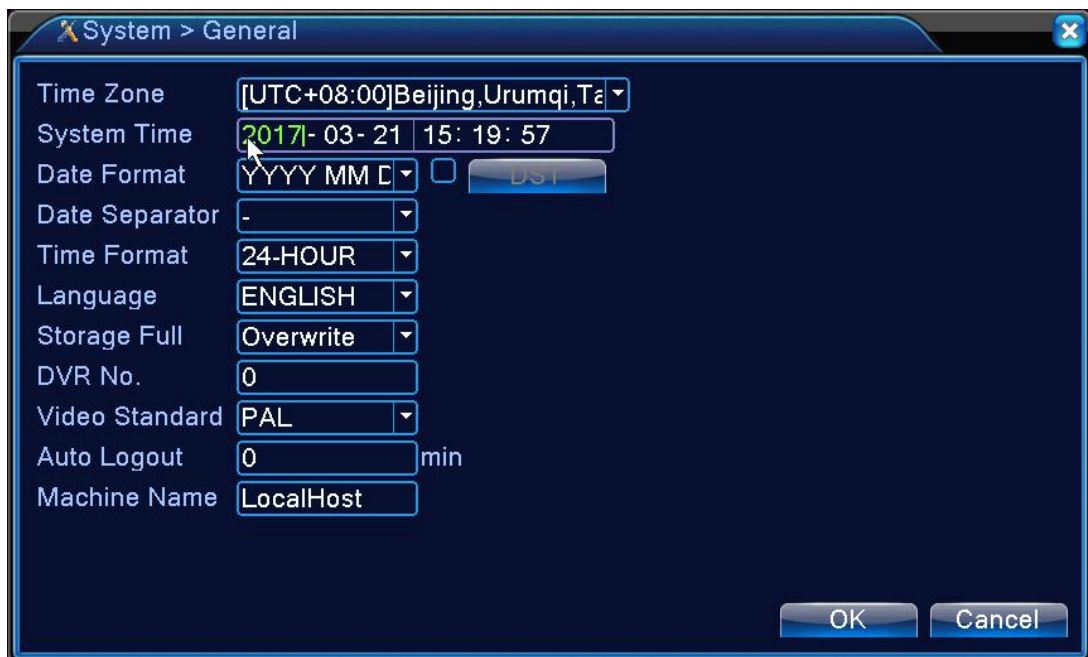

General setup

【System time】 Set the system data and time.

【Date format】 Choose the data format: YMD, MDY, DMY.

【Date Separator】 Choose list separator of the data format.

【Time Format】 Choose time format: 24-hour or 12-hour.

【Language】 support 29 language at

present:Arabic,Czech,English,Finnish,Greek,Indonesian,Italian,,Japanese,Portuguese,Russian,Thai,T-Chinese,S-Chinese,Turkish,Brazilian,Bulgarian,Farsi,French,German,Hebrew,Hungarian,Polish,Romanian,Spanish,Swedish,Vietnamese

【HDD full】 Choose stop record: Stop recording when the hard disk is full.

Choose overwrite: Cover the earliest recording files and continue recording when the hard disk is full.

【DVR No.】 Only when the address button in the remote controller and the corresponding DVR number is matched, the remote operation is valid.

【Video Standard】 PAL or NTSC.

【Auto Logout】 Set the latency time in 0-60. 0 means no latency time.

【Machine Name】 Can setting the device's name.

【DST】 Choose the summer time option and pop the dialog box as followed.

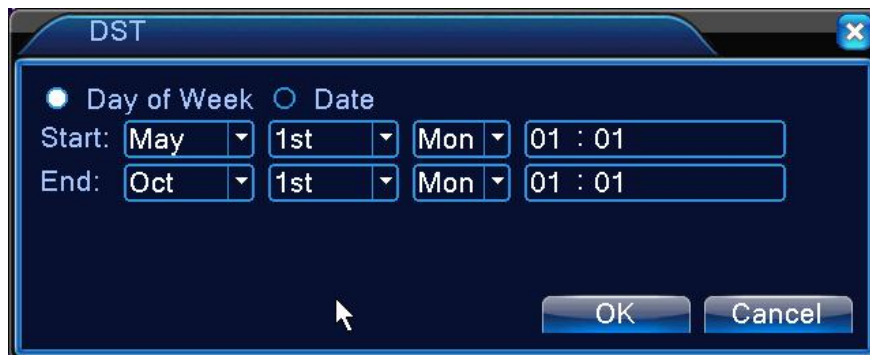

DST (week)

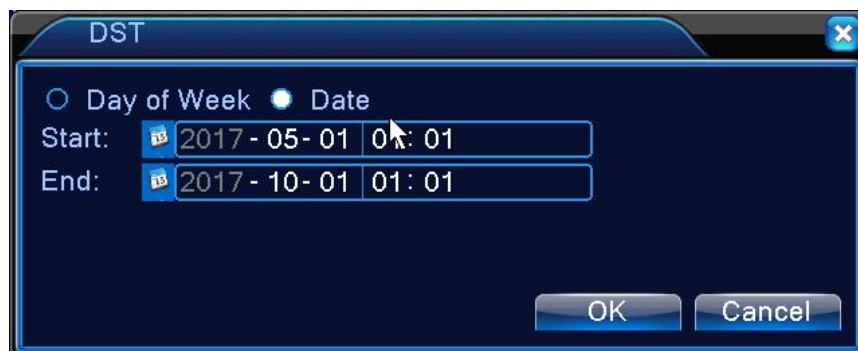

DST (date)

- **Encode setup**

***Encode settings is for analog channel only.**

Set the video/audio code parameter: video file, remote monitoring and so on. Set every main stream parameter in the left part, and set the extra stream parameter in the right part.

Note: extra stream introduces video compression technique which was applying for multi-channel playback simultaneously, Dial-up multi-channel real-time monitor under poor bandwidth, or mobile monitor and so on.



Encode setup

Independent channel code setting

【Channel】 Choose the channel number.

【Compression】 Standard H.264 main profile.

【Resolution】 Resolution type:1080P/720P/960H/D1/ HD1/CIF / QCIF.

【Frame Rate】 P:1 frame/s~25 frame/s; N: 1 frame/s~30 frame/s

【Bit Rate Type】 You can choose limited code stream or variable code stream. When you choose the variable code stream there are six image quality options. Under the limited code stream, you can choose the code stream manually;

【Bit Rate】 Set the code stream value to modify the image quality. The larger code stream value the

better image quality.

1080P(1024~8192kbps) 720P(1024~4096kbps) 960H(869~4096kbps) D1 (512~2560kbps) HD1 (384~2048kbps) CIF (64~1024kbps) , QCIF(64~512kbps)

【Frame Interval】 can choose the range 2~12s

【Video/Audio】 When the icons are all in reverse displayed, the video file is video and audio multiplex stream.

Extra stream Settings

【Extra stream】 is used for client side monitoring & mobile monitoring.

【Channel title】 select channel title and then to choose whether need enable video & audio. The resolution, frame rate, bit rate type settings is the same as main stream.

【Coding mode】 There are three coding mode: High Profile, Main Profile and Baseline which you can choose when you click the drop-down menu. High Profile is the best, Baseline is the worst.

- **Network setup**

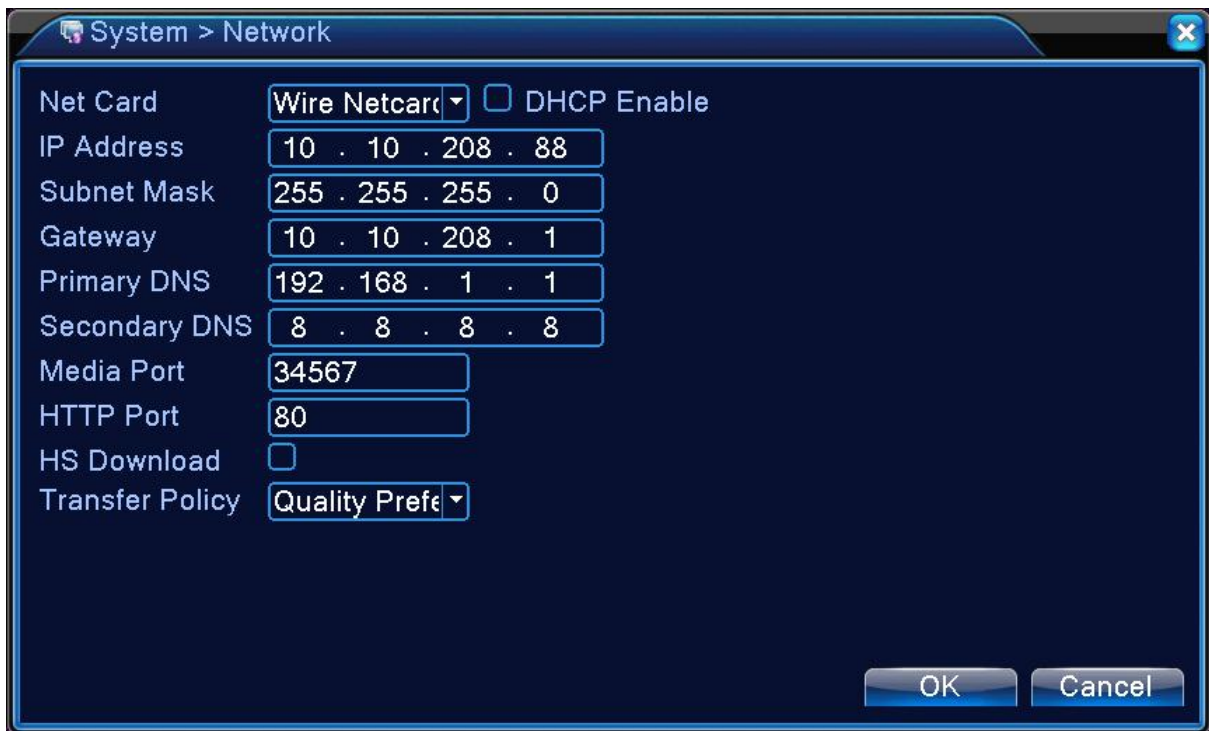

Network

【Net Card】 You can choose cable network card or wireless network card.

【DHCP Enable】 Obtain IP address automatically(not suggested)

Note: DHCP server is preinstalled.

【IP address】 Set the IP address. Default: 192.168.1.10.

【Subnet mask】 Set the subnet mask code. Default: 255.255.255.0.

【Gateway】 Set the default gateway. Default: 192.168.1.1.

【DNS setup】 Domain Name Server. It translates the domain name into IP address. The IP address is offered by network provider. The address must be set and reboot then it works.

【Media port】 Default: 34567.

【HTTP port】 Default: 80.

【HS Download】 It can improve the speed of downloading video files if enable HS download.

【Transfer Policy】 There are three strategies: self-adaption, image quality precedence and fluency precedence. The code stream will adjust according to the setup. Self-adaption is the tradeoff between the image quality precedence and fluency precedence. Fluency precedence and self-adaption are valid only when the assistant code stream is turned on. Otherwise image quality precedence is valid.

- **NetService**

Choose the network service option and click the set button to configure the advanced network functions or double click the service button to configure the parameters.



NetService

【PPPoE setup】

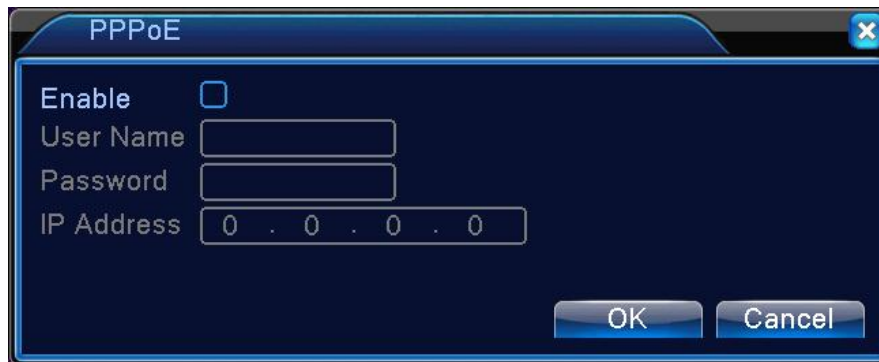

PPPOE

Enable: Reverse means choose, setting can become effective.

Input the user name and password that ISP (Internet service provider) provides. After saving it reboot up your system. Then the DVR will build a network connection based on PPPoE. The IP address will change into dynamic IP address after above operation is well done.

Operation: After PPPoE dialing successfully look up the IP address in the [IP address] and obtain the current IP address. Then use this IP address to visit the DVR through user port.

【NTP setup】



NTP

The NTP server must be installed in the PC.

Enable: Reverse mean choose, setting can become effective.

Custom: It can adjust the time of device according to the server you connected.

Sever IP: Input the IP address installed NTP server.

Port: Default: 123. You can set the port according to NTP server.

Update Period: The same with the NTP server check interval. Default: 60minutes.

【EMAIL setup】

If the alarm is turned on or the alarm linkage photos are taken, send an email about the alarm information and the photos to appointed address.



The screenshot shows a dialog box titled "EMAIL" with a close button in the top right corner. The dialog contains the following fields and controls:

- Enable:** A checkbox that is currently unchecked.
- SMTP Server:** A text input field containing the placeholder text "Your SMTP Server".
- Port:** A text input field containing the number "25".
- Need SSL:** A checkbox that is currently unchecked.
- User Name:** An empty text input field.
- Password:** An empty text input field.
- Sender:** An empty text input field.
- Receiver:** An empty text input field.
- Title:** A text input field containing the text "Alarm Message". A mouse cursor is pointing at this field.

At the bottom of the dialog, there are three buttons: "Mail Testing", "OK", and "Cancel".

EMAIL

SMTP server: Email server address. It could be an IP address or domain name. Domain name can be translated only if it is the correct DNS configuration.

Port: Email server port number.

SSL: Decide whether using Secure Socket Layer protocol to login.

User Name: Apply the email server user name.

Password: Input the password corresponding to the user.

Sender: Set the email sender address.

Receiver: Send the email to appointed receivers when the alarm is turned on. You can set three receivers at most.

Title: You can set as you wish.

【IP Filter setup】

When choosing the white list, only the listed IP address can connect the DVR. The 64 IP addresses are supportive in the list.

When choosing the black list, the listed IP address can not connect the DVR. The 64 IP addressed are supportive in the list.

You can delete the set IP address by √ in the options.

Note: When the same IP address is in the white and black list at the same time, the black list precedence is higher.



IP FILTER

【DDNS】

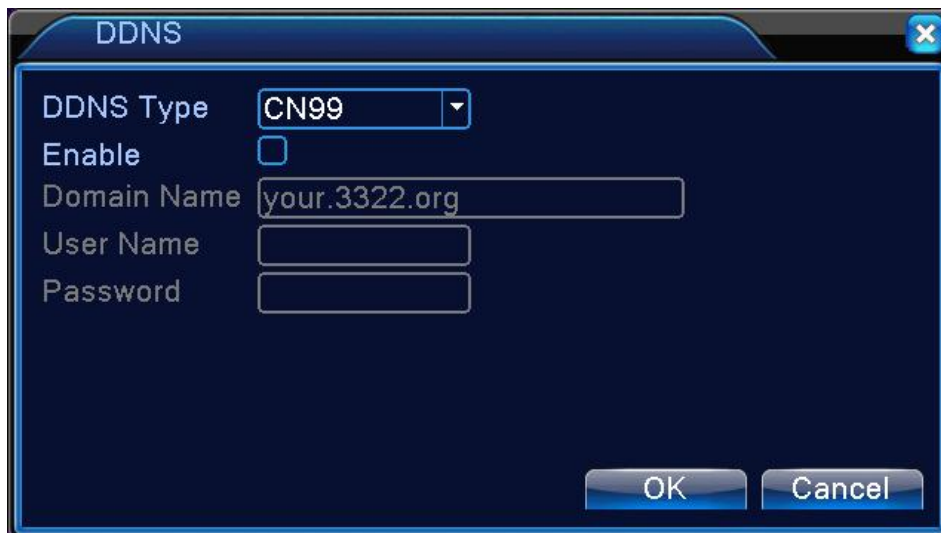

DDNS setup

It is the abbreviation of dynamic domain name server.

Local domain name: Provide the domain name registered by DDNS.

User name: Provide the account registered by DDNS. **Password:**

Provide the password registered by DDNS.

When the DDNS is successfully configured and start, you can connect the domain name in the IE address column to visit.

Note: The DNS setup must be configured correctly in the network setup.

【FTP setup】

FTP is available only when alarm happens,or alarm activates record and snapshot,it will upload related record and snapshot pictures to FTP server.

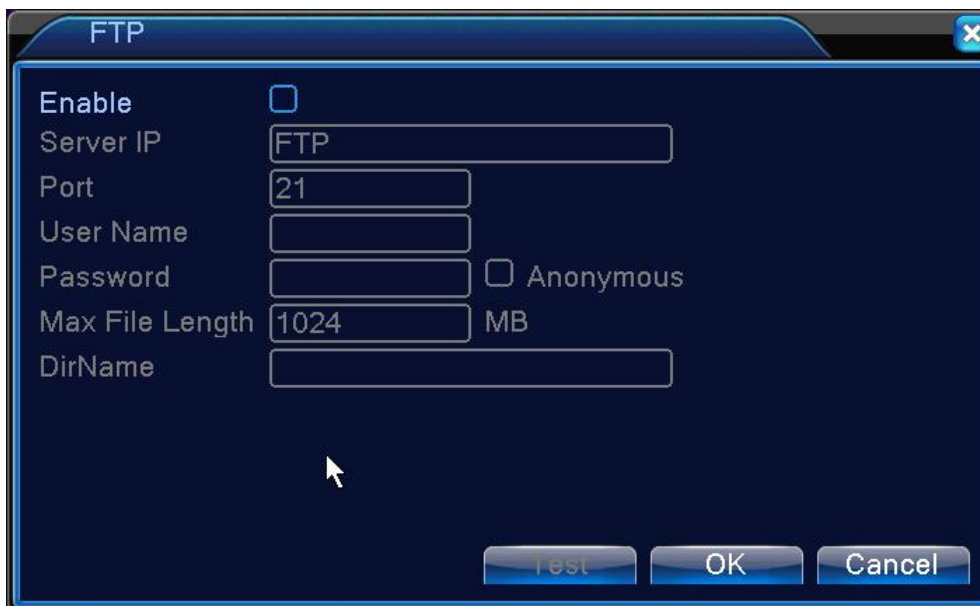

FTP setup

【Enable】 Click Enable, then all settings will be available

【Server IP】 IP address for FTP server

【Port】 Domain Port of FTP, default 21

【User Name】 User name of FTP

【Password】 Password of user

【Anonymous】: Enable anonymous, no need setting user name and password

【Max File Length】 Max length for upload files at every packed, default 128M

【Dir Name】: The directory of upload file.

Note: The user should be with authority to upload files.

【ARSP】

Startup DDNS server to add devices and manage it in the DDNS server

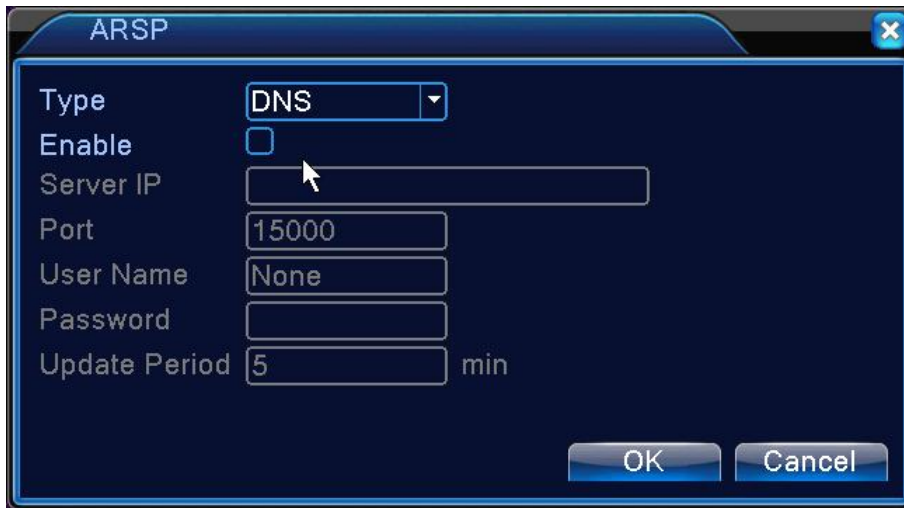

ARSP

【Type】 choose "DNS"

【Enable】 means it is chosen

【Sever IP】 IP address of DDNS server

【Port】 Port No. of device, related DDNS server listen port

【User name】 the user name that device can log in DDNS server

【Password】 the password related to the user name.

Note: Please set up server before using DDNS.

【Alarm center】

When alarm occurring, report alarm information to alarm server.



Alarm server setting

【Protocol type】 GENERAL

【Enable】 To tick it means enable.

【Server Name】 IP address of Alarm Server

【Port】 Device Port No.

【Alarm Report】 Tick it means to report alarm information to server.

【Log Report】 Tick it, means to report log to server.

【Wireless Config】

ADSL through 3G or 4G net card, use CMS to visit and config the device

A screenshot of a 'Wireless Config' dialog box. The dialog has a title bar with 'Wireless Config' and a close button. It contains several fields: 'Enable' with a checked checkbox, 'Type' with a dropdown menu showing 'EVDO', 'Wireless AP' with a text box containing 'ChinaNet', 'Dial Number' with a text box containing '#777', 'User Name' with a text box containing 'ctnet@mycdm', 'Password' with a masked text box of 10 dots, and 'IP Address' with a text box containing '0 . 0 . 0 . 0'. At the bottom right are 'OK' and 'Cancel' buttons.

Wireless Config

【Enable】 Choose Enable to make all settings available

【Type】 Dial type,default AUTO

【Wireless AP】 3G access point

【Dial Number】 3G Dial Number

【User Name】 User name of 3G

【Password】 Password of dial user

【IP Address】 IP address, got from dial

【UPNP】

UPNP protocol is to realize auto port forwarding on router, precondition of using this function is to make sure the UPNP function of router is enabled.

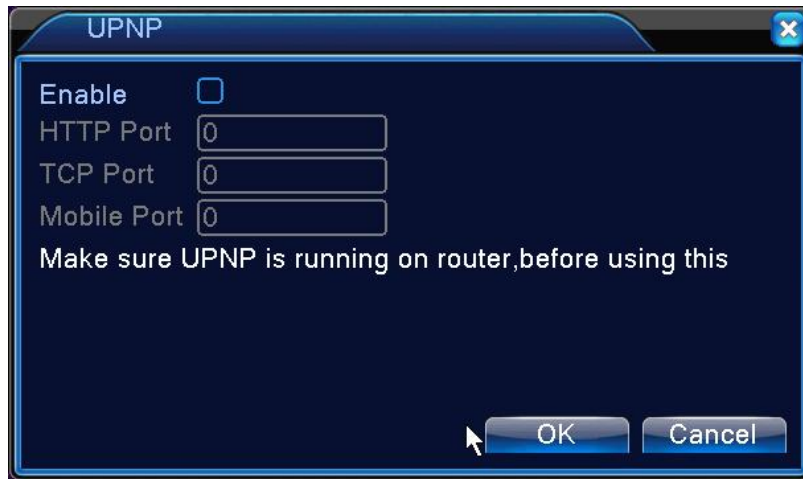

UPNP

【Enable】 Choose Enable to make sure all UPNP settings available

【HTTP】 Router will automatically distribute HTTP port for the device, when IE viewing, it needs this port

【TCP】 Router will automatically distribute TCP port for the device, when monitoring via CMS, it needs this port.

【Mobile Port】 Router will automatically distribute Mobile Port for the device, when mobile monitor, it needs this port.

【WIFI】

DVR connects to wireless router via WIFI module, then to visit it through IP address, the precondition of using this function is to make sure the DVR has connected with WIFI modem.

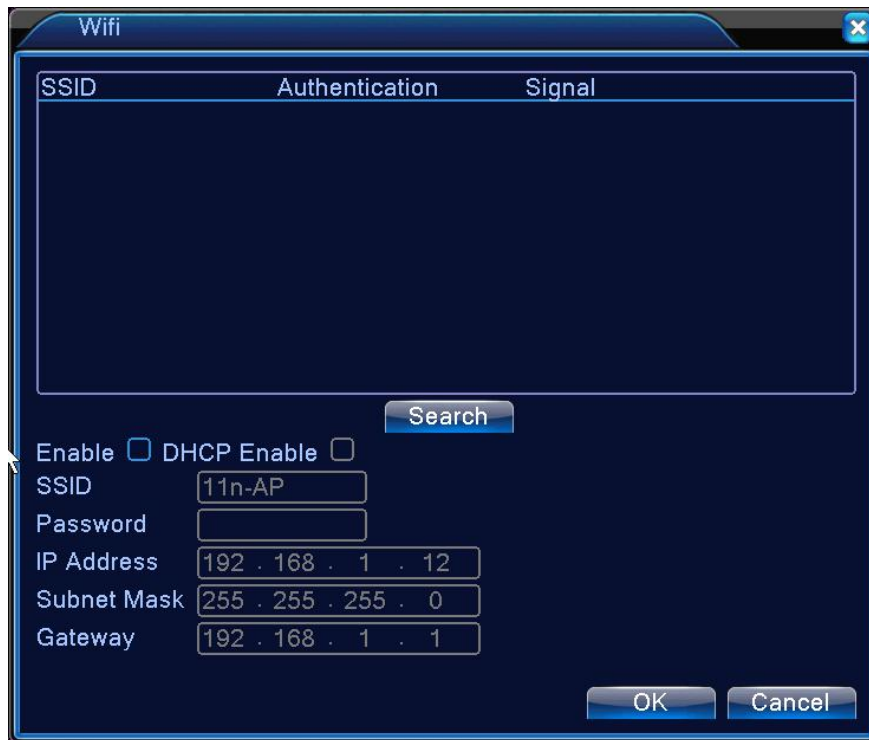

WIFI configure

【Search】: click **【search】** to search all the available wireless device in current range.

【enable】: tick it to enable firstly, then go for further setting.

【auto obtain IP address】: tick it to enable, device will auto obtain a WIFI IP.

【SSID】: wireless LAN name, auto match to the wireless device u connected.

【Password】: wireless network password of router;

【IP address】 : to set the IP address of device, default is 192.168.1.12

【subnet mask】 : set subnet mask of device, default is 255.255.255.0

【gateway】: set gateway of device, default is 192.168.1.1

【RTSP】

To do surveillance via cross-browser (Safari, Firefox, Google chrome) and VLC software. **This function only for monitor but can not control the device.**

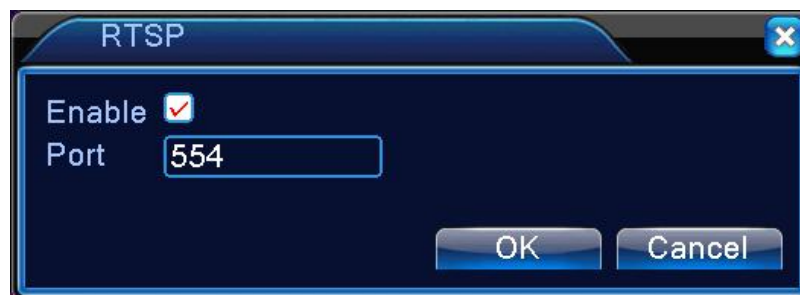

RTSP setting

【Enable】: ■ means enable, tick it firstly before setting.

【Port】: the default port is 554

【CLOUD】

Check the cloud services, male cloud service is enabled, the user can visit <http://www.xmeye.net>

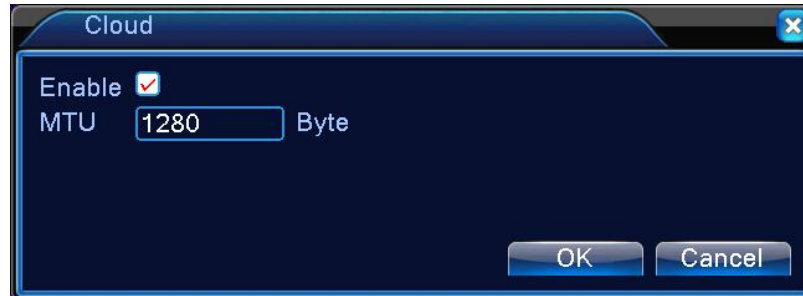

Cloud setting

【Enable】 Select it to make sure abnormal function workable

【PMS/Mobile reported】

Enable this function, at the same time open the function in the mobile end, exit the application, when the alarm occurs, check the cell phone to report, will send information to cell phones.

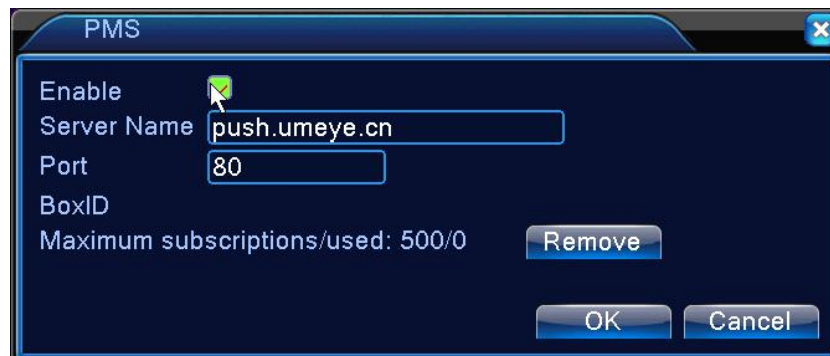

PMS

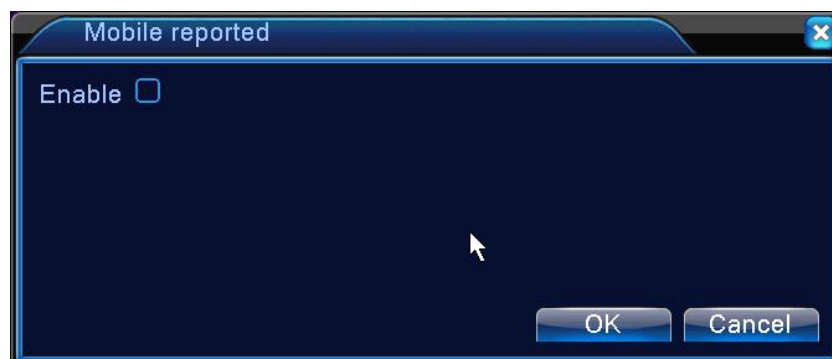

Mobile reported

【Enable】 Select it to make sure abnormal function workable

【Server Name】 default: push.umeye.cn

【Port】 the default port is 80

- **GUI Display**

Configure the video output parameters including the front output mode and encode output mode.

Front output: In the local preview mode include: channel title, time display, channel display, record status, alarm status, transparency and region cover.

Encode output: In the network surveillance and video file mode include: channel title, time display, channel display, record status, alarm status, transparency and region cover.

***Remark: Only 6000 series product support preview resolution - 1920*1280(1080P)**

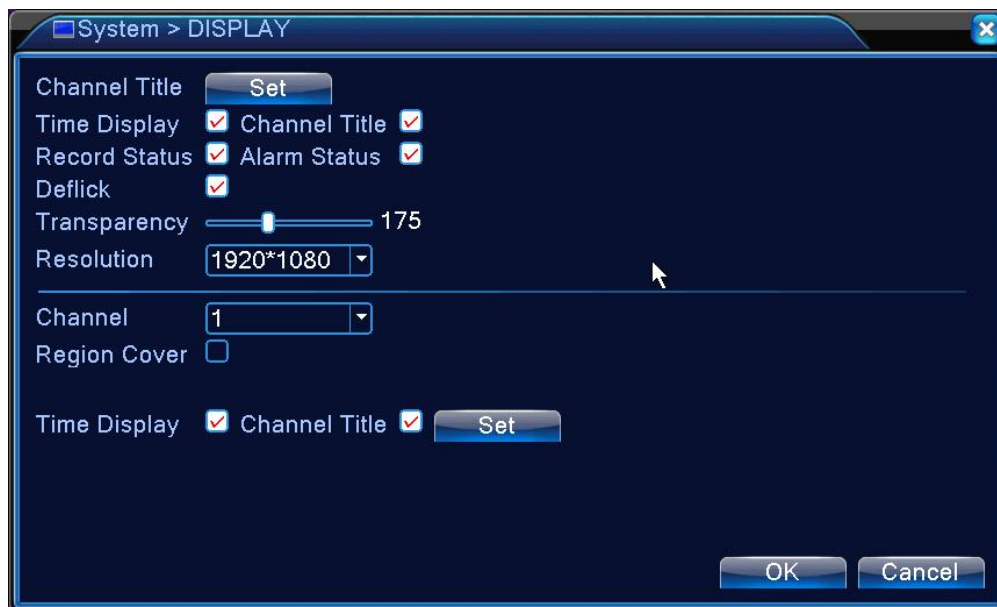

Display

【Channel Title】 Click the channel name modify button and enter the channel name menu. Modify the channel name. The 16 Chinese characters and 25 letters are supportive.

【Time Display】 means the selective state. Display the system data and time in the surveillance window.

【Channel display】 means the selective state. Display the system channel number in the surveillance window.

【Record Status】 means the selective state. Display the system recording status in the surveillance window.

【Alarm Status】 means the selective state. Display the system alarm status in the surveillance window.

【Transparency】 Choose the background image transparency. The range is 128~255.

【Resolution】 set display resolution.

【Channel】 Choose the set code output channel number.

【Region Cover】 means the selective state. Click the cover area button and enter the corresponding channel window. You can cover the arbitrary using mouse. (Black region is for output)

【Time display】 and 【Channel display】 set the display position of channel title and time title.

***the channel no., region cover, time title and channel title setting function exist at output mode only when the device is under hybrid(HVR) mode or full analog(DVR) mode.**

• **PTZ device /RS485 device**

*** When under hybrid mode/full digital mode, it shows with PTZ device and RS485 device; *When under full digital mode, it will show RS485 device only.**



PTZ config

【Channel】 Choose the dome camera input channel.

【Protocol】 Choose the corresponding dome protocol. (PELCOD as an example)

【Address】 Set as the corresponding dome address. Default: 1. (Note: The address must be consistent with the dome address.)

【Baudrate】 Choose the corresponding dome baud rate length. You can control the PTZ and vidicion. Default: 115200.

【Data bits】 Include 5-8 options. Default: 8.

【Stop bits】 Include 2 options. Default: 1.

【Parity】 Include odd check, even check, sign check, blank check. Default: void.

Note: The protocol, address and baudrate of the DVR must be same with the PTZ, or you can not control the PTZ.

- **RS232**

***T series do NOT support this function.**

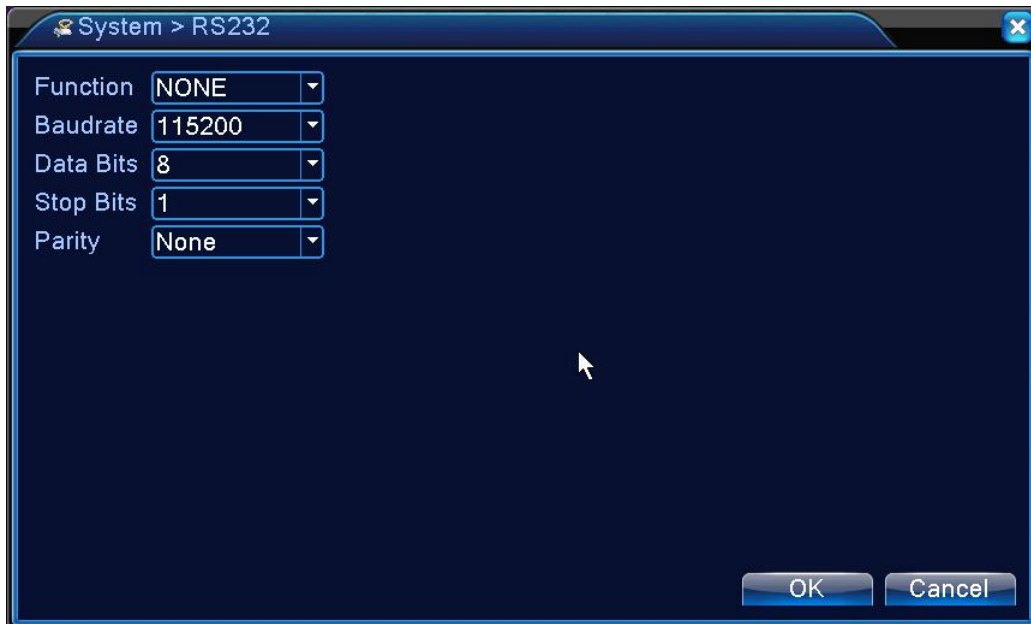

RS232

【Serial Port Function】 Common serial port is used to debug and update program or set up specific serial port.

【Baud rate】 Choose the corresponding baud rate length.

【Data bits】 Include 5-8 options.

【Stop bits】 Include 2 options.

【Parity】 Include odd, even, mark, space, default is none.

- **Tour**





Set the patrol display. ■ means that the tour mode is enable. You can choose the single-view, four-view, six-view of single mode tour or hybrid mode tour.



Tour configure

【interval】 Set the patrol switch interval. The set range is 5-120 seconds.

【alarm tour】 set the interval to shift alarm tour, range is 5-120 seconds, choose return when alarm ends, when alarm link to tour, system will auto shift to six-view after alarm finished.

Remark: at preview mode, click upper right icon  /  can turn on / off tour ( mean turn on,  mean turn off) .

- **Channel manage**

Digital manage including digital channel, channel status, and channel mode (**Remark: there is only analog mode if device is under full analog mode**):

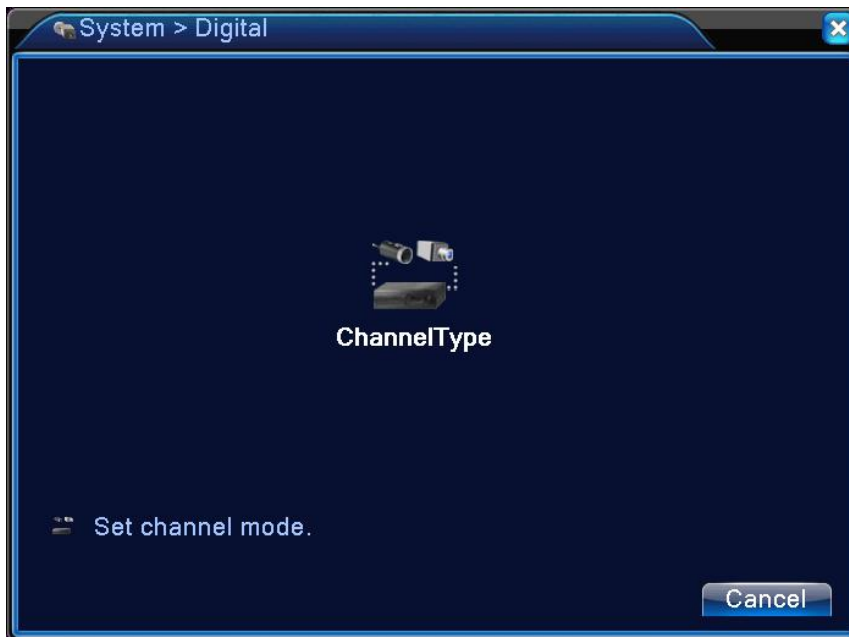

Channel manage page under all analog(DVR) mode



Channel manage page under Hybrid(HVR) mode / full digital(NVR) mode

Digital channel:

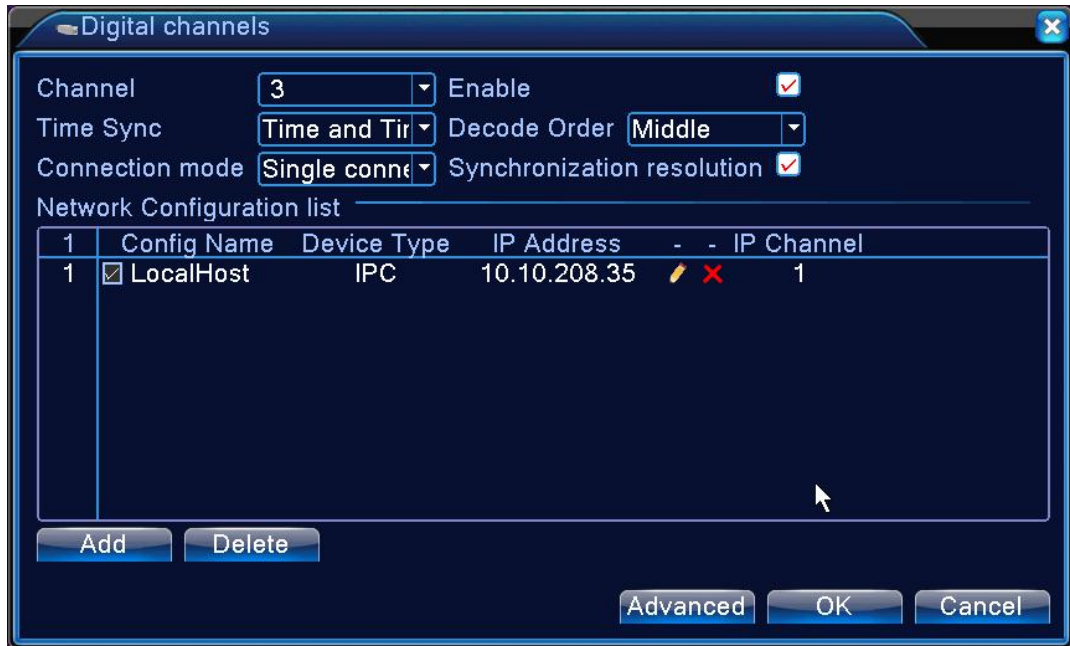

Single link page of digital channel

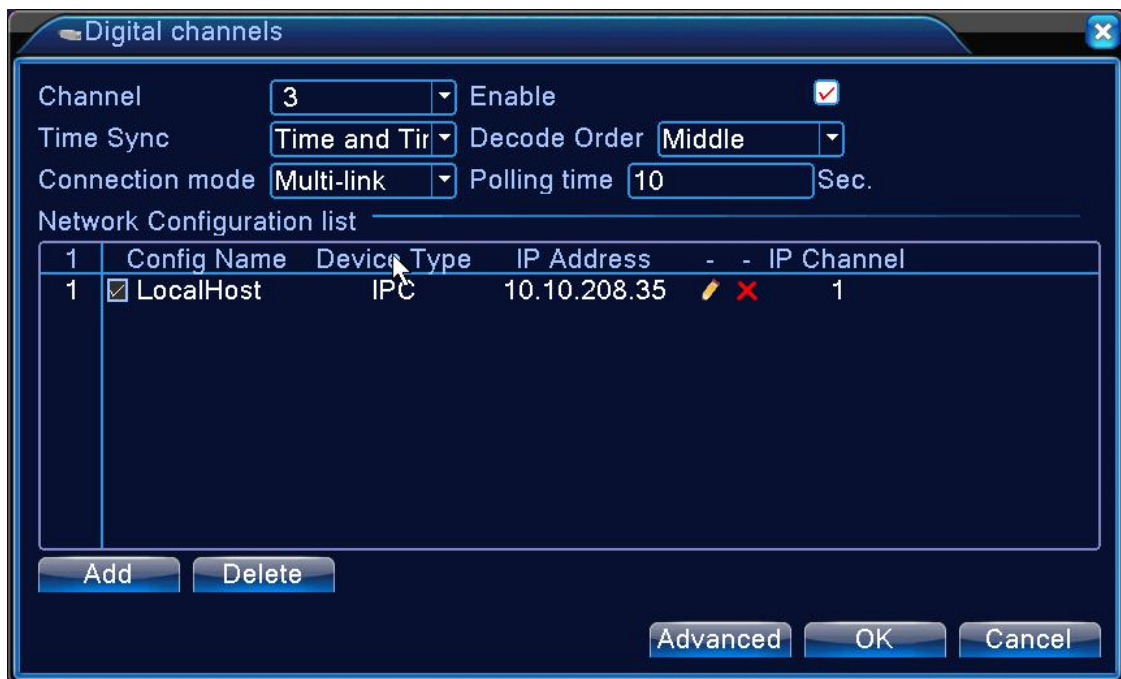

Multi-linkage page of Digital channel

【Channel】 select channel title

【Enable】 Open digital channel, tick enable, then can do related settings

【Time Synchronization】 Tick it means the time of this channel and device is the same.

【Connection Mode】 can be single connect or multi-link, multi-link modes can connect to several devices, device will be tour displayed one by one, tour interval can be set, no less then 10s;

【Delete】 If the user want to change device, select the existing device, click delete will be ok.

【Add】 click add will come out below page to add new device

0	Device Name	Device Info.	IP Address	Port
---	-------------	--------------	------------	------

remote channel configure page

【Configure Name】 device is with default configure title, user can revise it if necessary;

【Device Type】 3 types: IPC、DVR、HVR, user can choose as what you like, default is IPC;

【Protocol】 Default is TCP

【Remote channel】 User can input remote channel title from the device that you want to connect remotely

【Stream】 Default is main stream, do not support extra-stream at present;

【Device address】 IP address of device.

【Port】 Default is 34567

【User name】 Default is admin

Remark: click **【search】** will show all the devices that searched out, user can choose any of the device that you like.

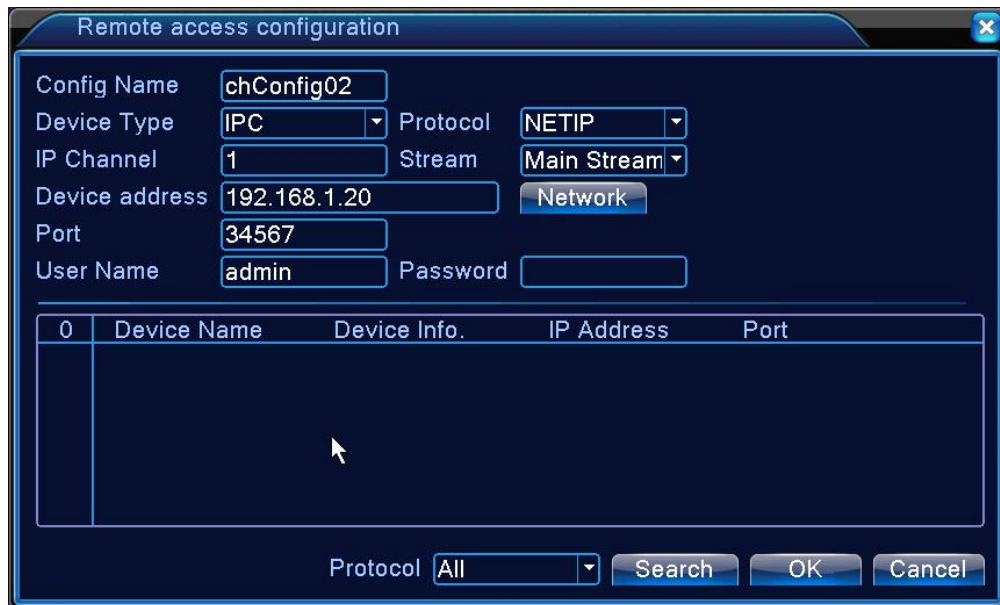

the device list searched under remote channel setting

Channel Status:

Channel status is to show the status of all the digital channel When there is what existing, status including Max Resolution, This Resolution, Connection Status.

For example: The channel status for 2+2 mode is as below:



D03 channel is connected, and D04 channel doesn't add the remote device.

Remark: when the current resolution is over the max resolution that the channel supported, then a red "X" will be shown on the preview image, for example: Under full digital channel mode, Max resolution of channel 3 is D1, if it was connected to a device with resolution over D1 (such as

960H), you will see below pic:

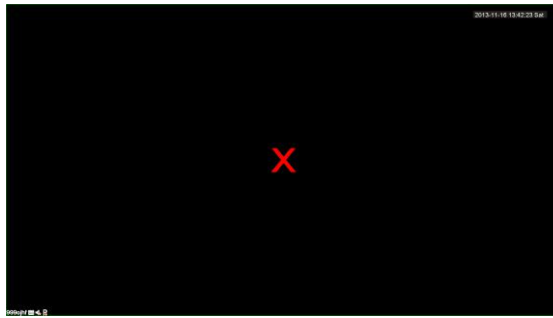

Channel type:

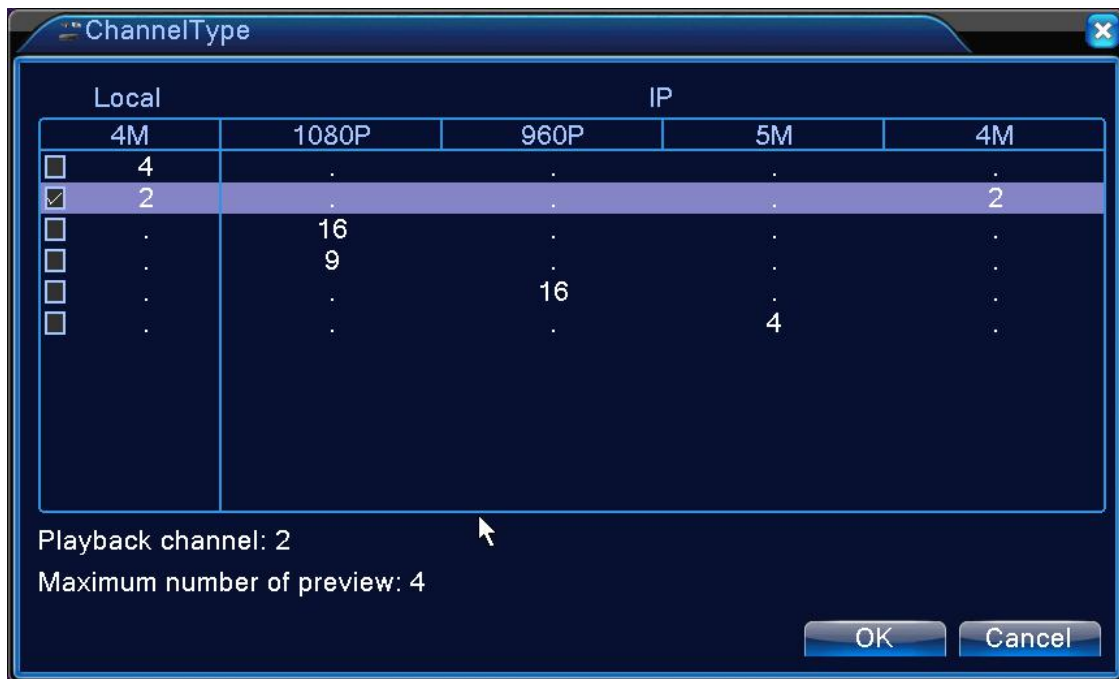

Remark: this series of product with full analog channel mode, hybrid mode and full digital mode, and different model with different channel mode, user can shift the mode freely if necessary.

- **IPC param.**

Refer to chapter 3.6.12. IPC param.

- **Advanced**

Manage tools menu including: HDD manage, account manage, online user, output adjust, auto maintain, upgrade.



Advanced

- **HDD Manage**

Configure and manage the hard disk. The menu displays current hard disk information: hard disk number, input port, type, status and overall capability. The operation include: setup the write-read disk, read-only disk, redundant disk, hard disk format, resume default. Choose the hard disk and click the right function button to execute.

Note: Read/Write Disk: The equipment can write or read data.

Read-only Disk: The equipment can read data but can not write data.

Redundant Disk: Double backup the video files in the write-read disk.

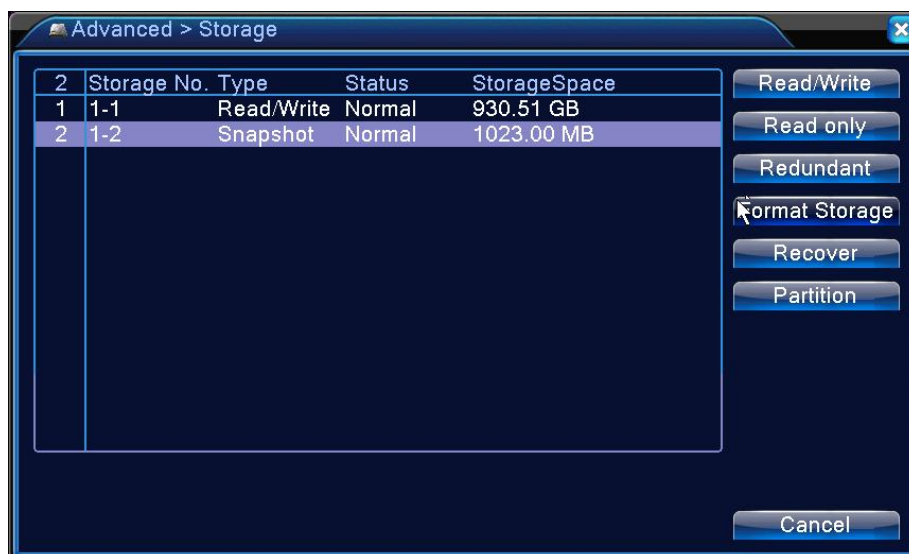

HDD manage

- **Account**

Manage the user purview.

Note: 1. The character length is 8 bytes at most for the following user and user team name. The blank ahead or behind the character string is invalid. The middle blank in the character string is valid.

Legal characters include: letter, number, underline, subtraction sign, dot.

- There is no limit in the user and user group. You can add or delete the user group according to user definition. The factory setup include: user\admin. You can set the team as you wish. The user can appoint the purview in the group.
- The user management include: group/ user. The group and user name can not be the same. Each user only belongs to one group.

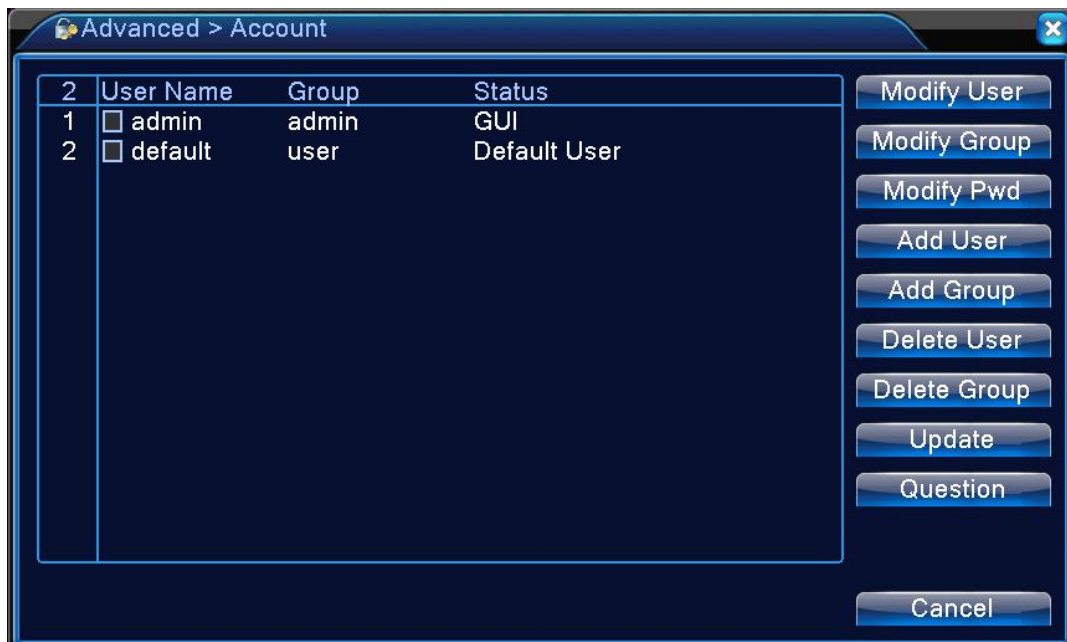

Account management

【Modify User】 Modify the existed user attribute.

【Modify Group】 Modify the existed team attribute.

【Modify Password】 Modify the user password. You can set 1-6 bit password. The blank ahead or behind the char string is invalid. The middle blank in the char string is valid.

Note: The user who possess the user control purview can modify his/her own or other users password

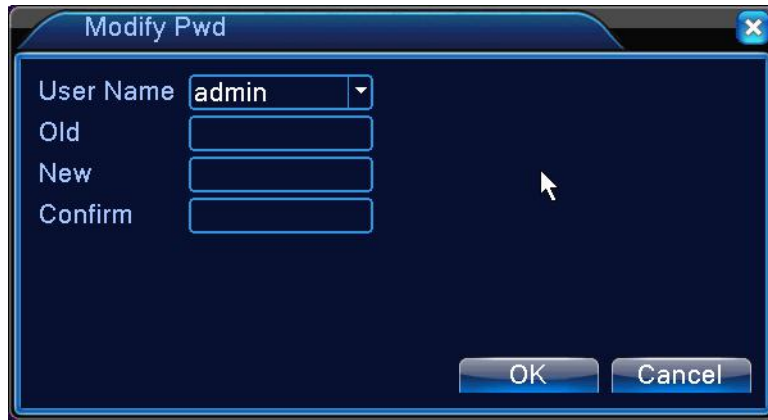

Modify password

【Add user】 Add a user in the group and set the user purview. Enter the menu interface and input the user name and password. Choose the team and choose whether cover using the user. Cover using means that the account can be used by multiple users at the same time.

Once choose the team the user purview is the subclass of the team.

We recommend that the common user's purview is lower than the advanced user.

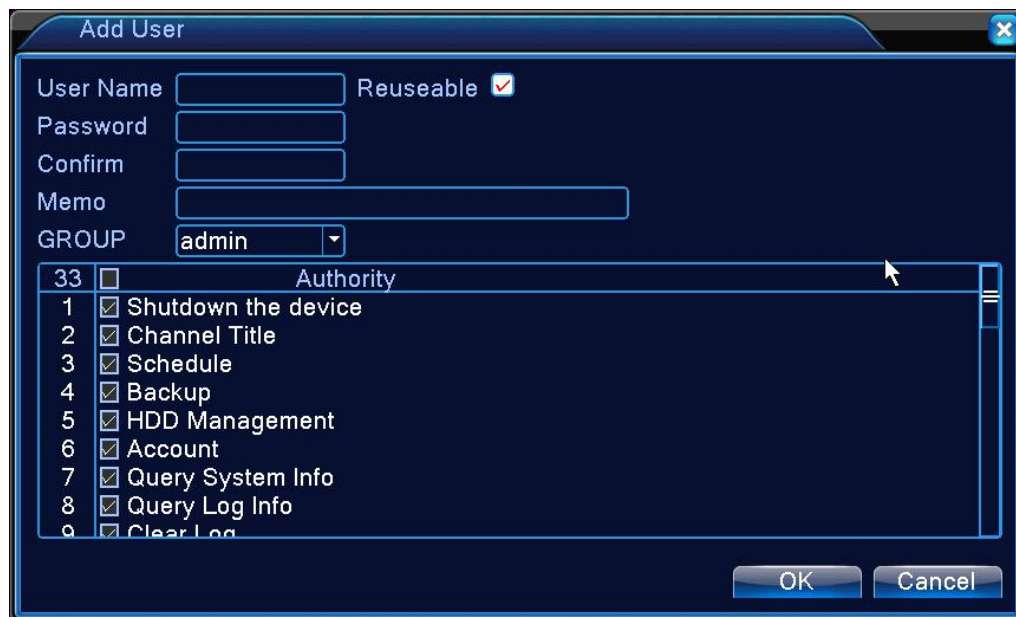

Add User

【Add Group】 Add a user group and set the purview. There are 33 different purviews: shut down the equipment, real time surveillance, playback, record setting, video backup and so on.

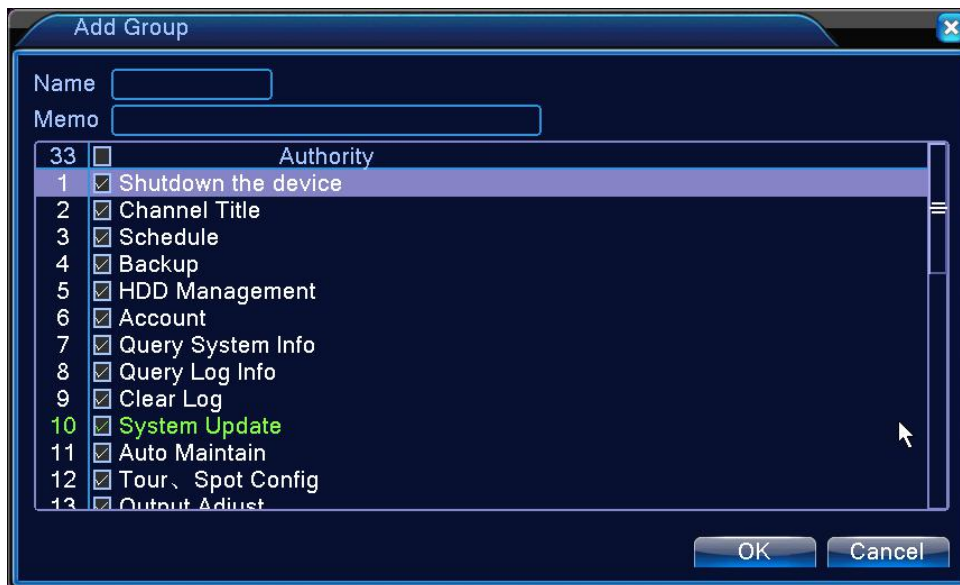

Add group

【Delete User】 Delete the current user. Choose the user and click delete user button.

【Delete Group】 Delete the current group. Choose the group and click delete group button.



Delete Group

8.Safety question

Set one or two different safety questions as below picture shows, and then fill in the answer and confirm answer, then click OK and cancel to exit. After that you can reset the password when you forget it through the safety question.



Safety question

- **Online user**

To check the information of network user that connected with local device, also can tick the selected user to break up connection, (make \surd at the box), then the user will be frozen after connection stopped, and will not log in until device reboot.

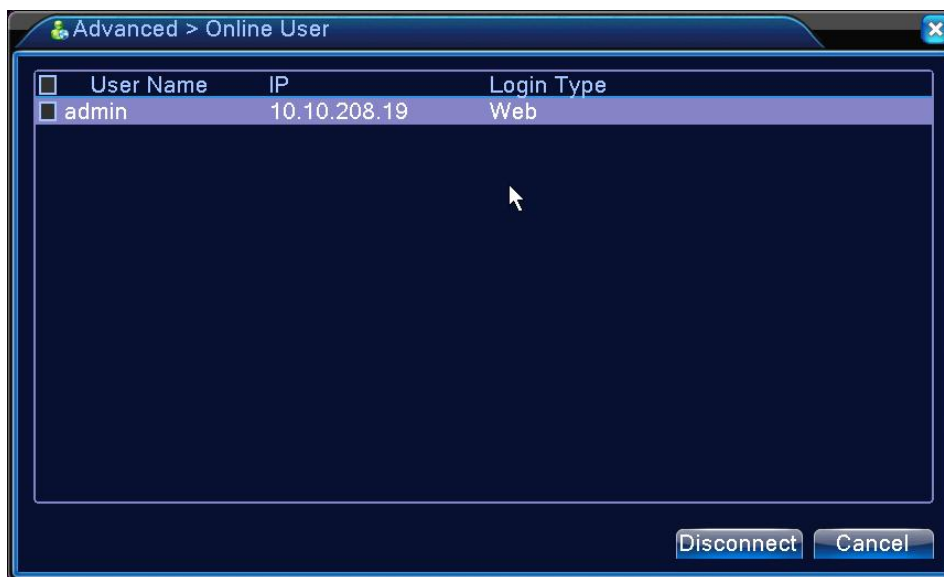

Online user

- **Output adjust**

Refer to chapter 3.6.8 .

- **Auto Maintain**

The user can set the time to auto reboot and auto delete file.

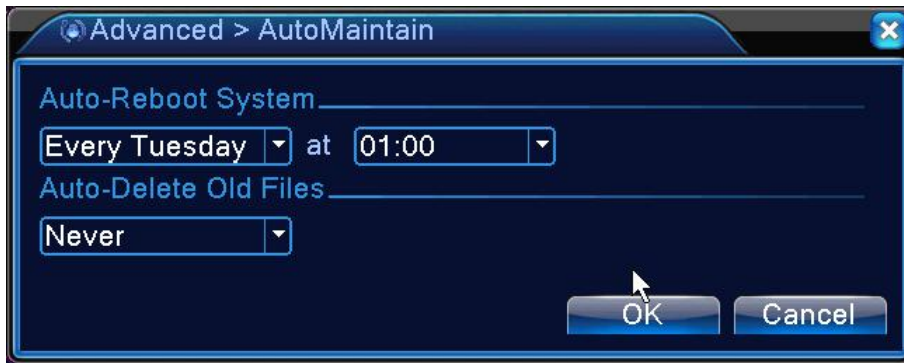

Auto maintain

- **Restore**

The system restore to the default. You can choose the items according to the menu.

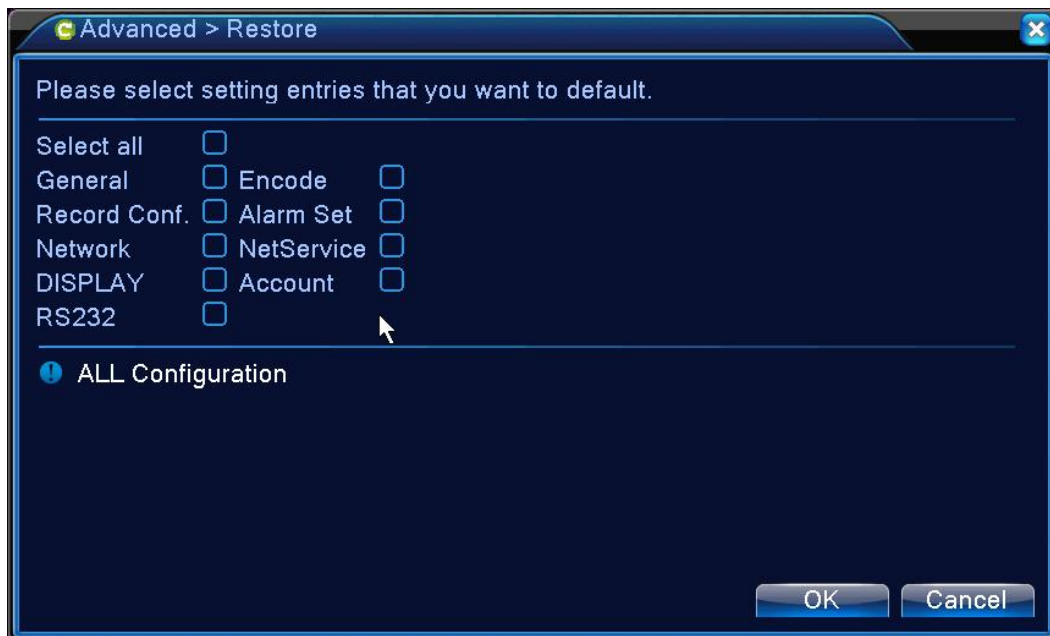

Restore

- **Upgrade**

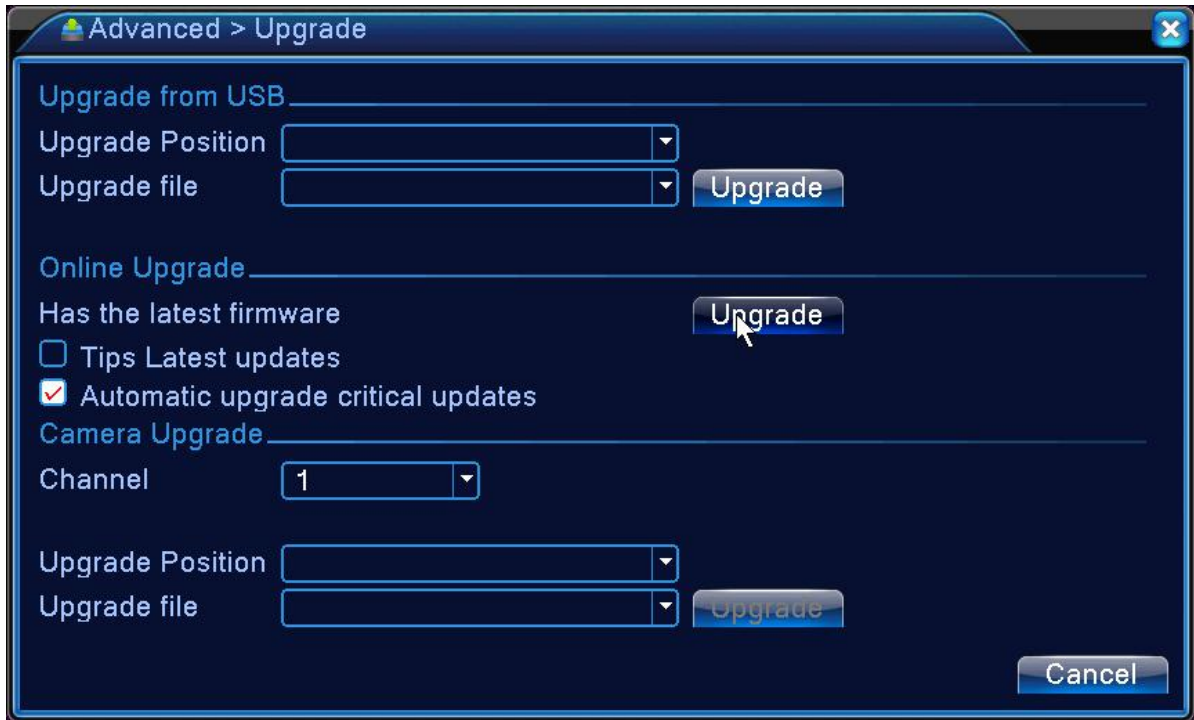

Upgrade

Upgrade from USB: Plug the U disk, upgrade the device use the upgrade file in U disk.

【Upgrade Position】 choose **USB interface**.

【Upgrade file】 choose the **upgrade file**.

Online Upgrade: When you connect your DVR to WAN, it will make comparison of the firmware version of the DVR and the firmware version of the server. It will upgrade if find the latest firmware.

Camera Upgrade: Plug the U disk, upgrade the AHD camera (some model support)/ IPC (when in IP mode or HVR mode) use the upgrade file in U disk.

Note: Please don't cut off the power when upgrade, it will cause serious consequences; and please check the upgrade firmware if it is for the DVR model when upgrade failed.

- **Device Info**

Provide device interface info like audio in, alarm in/out to be conveniently used for user.



Device info

- **Import / Export**

Users can export the log info and the configure file from device to connected flash stick, and also can import related configure file from flash stick to settings, which greatly bring convenience to the customers.

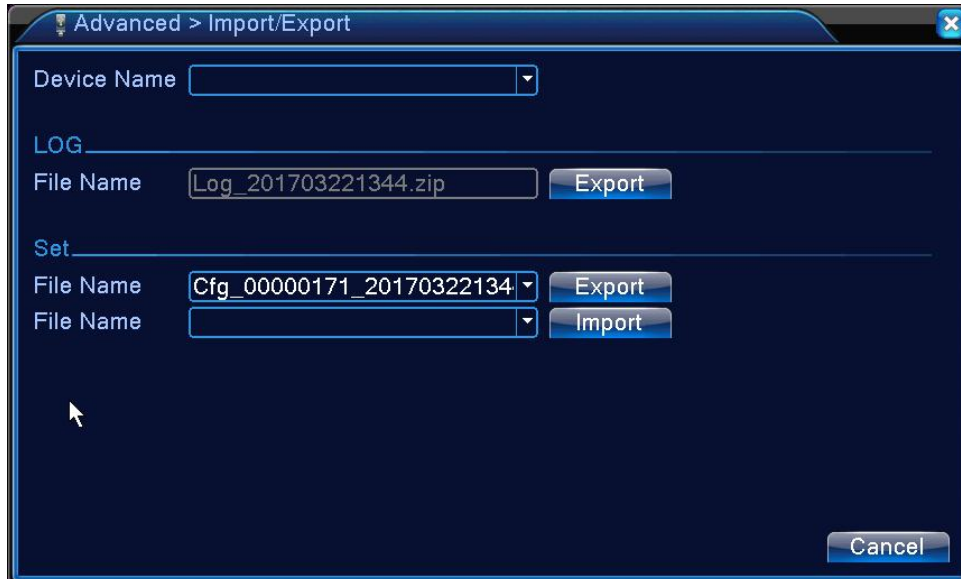

Import / Export interface

- **Info**

Display the hard disk information, including HDD info, code stream statistic, log info, version info

- **HDD info**

Display the hard disk state: hard disk type, overall capability, residual capability, the recording time and so on.



HDD info

Tips: 0 means that the hard disk is normal. X means that the hard disk is broken-down.- means that there is no hard disk. If the user need to change the damaged hard disk, you must shut down the DVR and take up all the damaged hard disks,then install a new one.

* behind serial number means the current working disk such as 1*. If the corresponding disk is damaged, the information will show "? ?".

- **BPS**

Display the code stream (Kb/S) and hard disk capability (MB/H) in real time. It displays as the wave sketch map.

Channel	Kb/S	MB/H
1	34	15
2	52	18
3	2515	1083
4	0	0

Cancel

BPS

- LOG

To search log information base on the set search mode.

Log information include: system operation, configuration operation, data management, alarm affair, recording operation, user management, file management and so on. Set the time section to look up and click the look up button. The log information will display as a list. (one page is 128 items) Press **Page up** or **Page down** button to look up and press **delete** button to clear all the log information.

Type: All

Start Time: 2017-03-22 00:00:00

End Time: 2017-03-23 00:00:00

27	Log Time	Type	LOG
1	2017-03-22 11:13:34	save system state	2017- 3-21 17:50:03
2	2017-03-22 11:13:34	Log In	default<GUI>
3	2017-03-22 11:14:42	Log Out	default<GUI>
4	2017-03-22 11:14:42	Log In	admin<GUI>
5	2017-03-22 11:15:11	Save Configuration	Digital Management
6	2017-03-22 11:15:11	Shut Down	2017- 3-22 11:15:11
7	2017-03-22 11:16:02	Reboot	2017- 3-22 11:15:11
8	2017-03-22 11:16:02	Log In	default<GUI>
9	2017-03-22 11:16:18	Log Out	default<GUI>
10	2017-03-22 11:16:18	Log In	admin<GUI>

Search Clear Cancel

Log information

- **Version**

Display the basic information such as hardware information, software version, issue date, serial number , NAT status and so on.

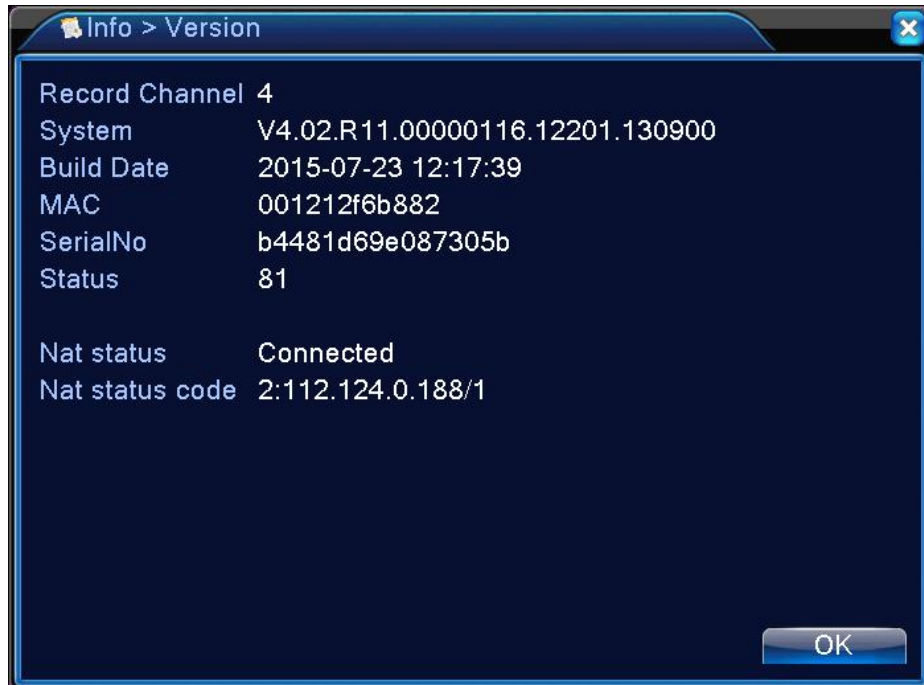

Version information

- **Shut down system**

Refer to chapter 3.6.2.

5 Cloud Technology Basic Operation

5.1 Cloud technology monitor

Cloud technology make the device one step on net, greatly bring convenience for customer to monitor via wide area network, this technology is using the serial no to visit device.

***Remark: the device that using cloud technology should be in the WAN(Wide Area Network)firstly.**

13 Check the connecting status of cloud technology

Connect device to WAN firstly, then enter **【Main menu】 > 【Info】 > 【Version】** to check whether the device successfully connect to the cloud server or not.

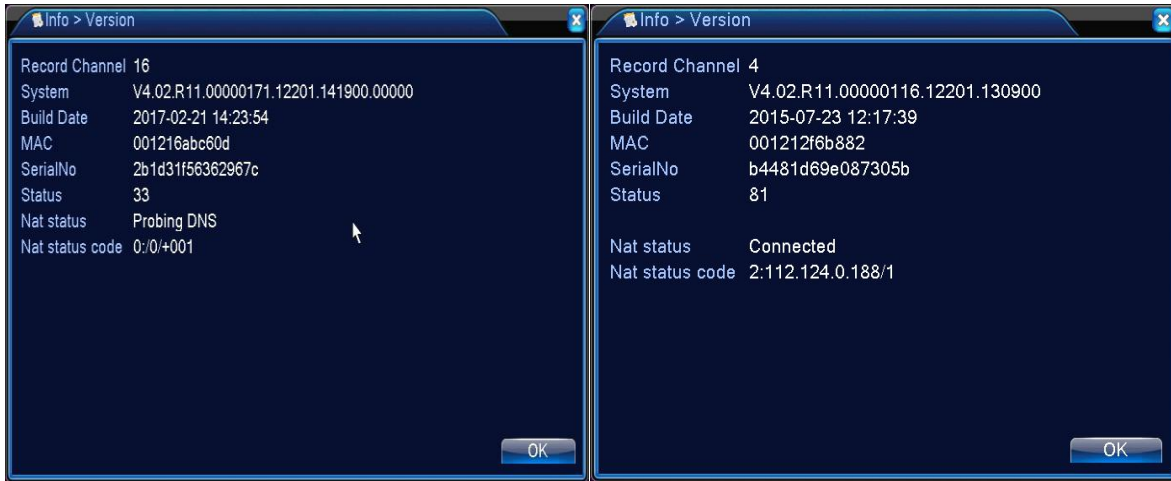

Connect failed interface

successfully connect interface

6 FAQ and maintenance

- **FAQ**

If the problems are not listed, please contact the local service or call the HQ service. We are willing to offer the service.

1、 The DVR can not boot up normally.

Possible reasons are as followed:

- The power supply is not correct.
- Switch power supply line is not in good connection.
- Switch power supply is damaged.
- The program updating is wrong.
- The hard disk is damaged or the hard disk lines are broken.
- The front panel is damaged.
- The main board of the DVR is damaged.

2、 The DVR reboots automatically or stops working after boot up a few minutes.

Possible reasons are as followed:

- 1 The input voltage is not stable or too low.
- 2 The hard disk is damaged or the hard disk lines are broken.
- 3 The power of the switch power supply is low.
- 4 Frontal video signal is not stable.
- 5 Bad heat radiator or too much dust or bad running circumstance for the DVR.
- 6 The hardware of the DVR is damaged.

3、 System can not detect hard disk.

Possible reasons are as followed:

- 1 The hard disk power supply line is not connected.
- 2 The cables of the hard disk are damaged.
- 3 The hard disk is damaged.
- 4 The SATA port of main board is damaged.

4、 There are no video outputs in single channel, multiple channels and all channels.

Possible reasons are as followed:

- 1 The program is not matched. Please update the program.
- 2 The image brightness is all 0. Please restore the default setup.
- 3 There is no video input signal or the signal is too weak.
- 4 The channel protection or the screen protection is set.
- 5 The hardware of the DVR is damaged.

5、 Real-time image problems such as the image color or the brightness distortion.

Possible reasons are as followed:

- 1 When using the BNC output, the option between the N mode or PAL mode is wrong and the image becomes black and white.
- 2 The DVR is not matched the monitor impedance.
- 3 The video transmission distance is too far or the loss of the video transmission line is too large.
- 4 The color and brightness setting of the DVR is wrong.

6、 I can not find the video files in local playback mode.

Possible reasons are as followed:

- 1 The data line of the hard disk is damaged.
- 2 The hard disk is damaged.
- 3 Update the different program with the origin program files.
- 4 The video files to look up are covered.
- 5 The recording is not on.

7、 The local video is not clear.

Possible reasons are as followed:

- 6 The image quality is too bad.
- 7 The reading program is wrong. Reboot up the DVR.
- 8 The data line of the hard disk is damaged.
- 9 The hard disk is damaged.
- 10 The hardware of the DVR is damaged.

8、 There is no audio signal in the surveillance window.

Possible reasons are as followed:

- 4 It is not an active tone arm.
- 5 It is not an active sound box.
- 6 The audio lines are damaged.
- 7 The hardware of the DVR is damaged.

9、 There is audio signal in the surveillance window but no audio signal in the playback state.

Possible reasons are as followed:

- 4 Setting issues: the audio option is not chosen.
- 5 The according channel is not connected with the video.

10、 The time is wrong.

Possible reasons are as followed:

- 4 Setting is wrong..
- 5 The battery is in bad connection or the voltage is too low.
- 6 The oscillation is damaged.

11、 The DVR can not control the PTZ.

Possible reasons are as followed:

- There is something wrong with the frontal PTZ.
- The setting, connection or the installation of the PTZ decoder is not correct.
- The connections are not correct.
- The PTZ setting of the DVR is not correct.
- The protocols of the PTZ decoder and the DVR are not matched.
- The address of the PTZ decoder and the DVR are not matched.
- When multiple decoders are connected, the far port of the PTZ decoder line A(B) must connect a 120 Ω resistance to reduce the reflection otherwise the PTZ control is not stable.
- The distance is too far.

12、 The motion detect is not working,

Possible reasons are as followed:

- 4 The time range set is not correct.

- 5 The motion detect area set is not correct.
- 6 The sensitivity is too low.
- 7 Limited by some hardware edition.

13、 I can not login via web or CMS.

Possible reasons are as followed:

- 4 The system is windows 98 or win me. We recommend updating to windows 2000sp4 or higher Version or installing the software for low edition.
- 5 ActiveX is hold back.
- 6 The version is not exceeded dx8.1. Update the display card driver.
- 7 Network connection failure.
- 8 Network setting issues.
- 9 Invalid password or user name.
- 10 The CMS is not matched the DVR program version.

14、 The image is not clear or there is no image in network preview state or video file playback state.

Possible reasons are as followed:

2. Network is not stable.
3. The user machine is resource limited.
4. Choose the play-in-team mode in the network setup of DVR.
5. The region shelter or channel protection is set.
6. The user has no surveillance purview.
7. The real-time image of the hard disk recording machine itself is not clear.

15、 Network connection is not stable.

Possible reasons are as followed:

1. Network is not stable.
2. IP address is conflicted.
3. MAC address is conflicted.
4. The net card of the DVR is bad.

16、 There is something wrong with the USB backup or writing a CD.

Possible reasons are as followed:

- 3 The rewritable machine and the hard disk are shared the same data lines.
- 4 The data is too much. Please stop recording and backup.
- 5 The data exceeds the backup storage.
- 6 The backup equipment is not compatible.
- 7 The backup equipment is damaged.

17、 The keyboard can not control the DVR.

Possible reasons are as followed:

- 3 The serial port of the DVR is not set correctly.
- 4 The address is not correct.
- 5 When multiple transformers are connected, the power supply is not large enough. Please give each transformer individual power supply.
- 6 The distance is too far.

18、 Alarm can not be recessional.

Possible reasons are as followed:

- 2 The setting of the alarm is not correct.
- 3 The alarm output is turned on manually.
- 4 The input machine is damaged or the connections are not correct.
- 5 There are some problems for specific program edition, Please update the program.

19、 Alarm is not working.

Possible reasons are as followed:

2. The setting of the alarm is not correct.
3. The connection of the alarm is not correct.
4. The alarm input signal is not correct.
5. A alarm is connected with two loops synchronously.

20、 The remote controller is not working,

Possible reasons are as followed:

- 2 The remote control address is not correct.
- 3 The remote control distance is too far or the angle is too large.
- 4 The battery is used up.
- 5 The remote controller or the front panel of the recording machine is damaged.

21、 The storage time is not enough.

Possible reasons are as followed:

2. Front vidicon quality is bad. The lens is too dirty. The vidicon is in backlighting installation.
3. The hard disk capability is not enough.
4. The hard disk is damaged.

22、 The downloading files can not play.

Possible reasons are as followed:

1. There is no media player.
2. There is no DX8.1 software or higher edition.
3. There is no DivX503Bundle.exe file to play AVI video files.
4. The DivX503Bundle.exe and ffdshow-2004 1012 .exe files must be installed in the windows xp system.

23、 I can not remember the advanced password or network code in the local menu operation.

Please contact the local service or call the HQ service. We will offer the service according the machine type and the program edition.

24、 Can not see the preview picture the digital channel

Possible reasons are as followed:

- 2 Did not add device
- 3 The device of related channel was not enable
- 4 The device of related channel was not selected.
- 5 The selected device did not connect to video sources
- 6 The channel title of selected remote device is not exist.
- 7 Stream for remote channel was set by extra stream.
- 8 User name & password not matched
- 9 directly input with IP address or port No. incorrectly when adding device.
- 10 The resolution of added device is too large to display by the monitor.

25、 Click ?search? why not search out any of the device.

Possible reasons are as followed:

- 1 There is no other device exist in the Local area network
- 2 The subnet mask setting incorrectly on Network settings.

26、 The snapshot at alarm function was enable, why not catch picture

Possible reasons are as followed:

- 1 HDD manage without partition for snapshot.
- 2 Partition for snapshot is 0
- 3 The snapshot function is not enable on record-> storage of related channel.

27、 The time shows on digital channel is not the same as local side:

Enable the time synchronous function of digital channel.

28、 Can not see preview picture of analog channel

Possible reasons are as followed:

1. The camera did not connect to video interface
2. The device did not connect to video source
3. Video source is broken.

29、 Picture will be frozen when multi-connection and shift devices.

Picture come out from digital channel need few seconds, shift device means to show new picture, so it needs several seconds to buffer.

• **Maintenance**

1. Please brush printed circuit boards, connectors, fans, machine box and so on regularly.
2. Please keep the grounding well done to prevent the video or audio signal interfered and the DVR from static or inductive electricity.
3. Do not pull out the video signal line or RS-232 port or RS-485 port with the power on.
4. Do not use the TV in the local video output port(VOUT) of DVR. It will damage the video output circuit easily.
5. Do not turn off the switch directly. Please use the turn-off function in the menu or press the turn-off button in the panel (3 seconds or longer) to protect the hard disk.
6. Please keep the DVR away from heat resource.
7. Please keep the DVR ventilated for better heat radiator.

Please check the system and maintain regularly.

Appendix 1.Remote controller operation

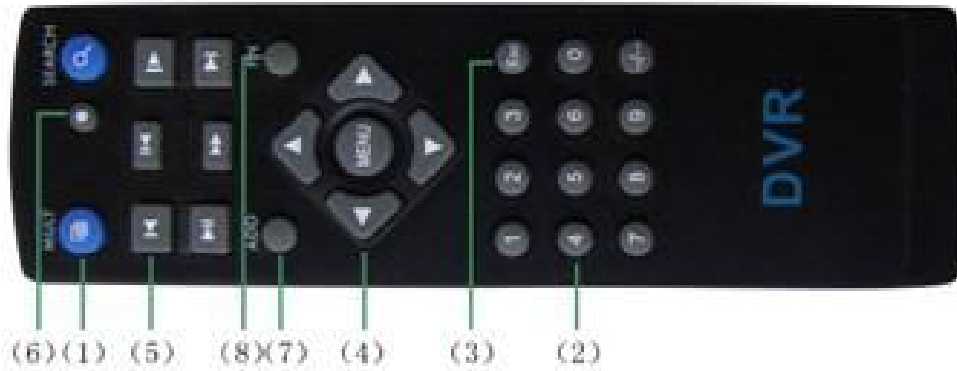

Serial number	Name	Function
1	Multi-window button	Same function as Multi-window button in the front panel
2	Numeric button	Code input/number input/channel switch
3	【Esc】	Same function as 【Esc】 button in the front panel
4	Direction button	Same function as direction button in the front panel
5	Record control	Control the record
6	Record mode	Same function as “Record mode”
7	ADD	Input the number of DVR to control it
8	FN	Assistant function

Appendix 2. Mouse operation

*Take right hand as an example

The mouse in USB connection is supported.

Operation	Function
Double left click	Double click one item in the file list to playback the video Double click the playback video to zoom in or out the screen
	Double click the channel to make it full screen display double click again to resume the multi-window display
Left click	Choose the according function in the menu
Right click	Pop desktop shortcut menu in preview state
	Current shortcut menu in the menu
Press middle button	Add or subtract number in the number setting
	Switch the items in the combo box
	Page up or down in the list
Move mouse	Choose the widget or move the item in the widget
Drag mouse	Set the motion detect area
	Set the cover area

Appendix 3.Hard disk capability calculation

Make sure the hard disk installed to the DVR for the first time. Pay attention to the IDE hard disk lines connection.

1、 Hard disk capability

There is no limit for recording machine. We recommend 120G~250G size to keep better stability.

2、 Overall capability option

The hard disk capability formula is:

Overall capability (M) =channel number*time (hour) *capability in an hour (M/hour)

The recording time formula is:

$$\text{Recording time (hour)} = \frac{\text{overall capability (M)}}{\text{Capability in an hour (M/hour)} * \text{channel number}}$$

The DVR introduces the H.264 compression technology. Its dynamic range is very large so the hard disk capability calculation is based on the estimation values of each channel creating files in an hour.

Example:

For one piece 500G HDD,real time CIF for recording,it will keep recording for about 25 days.HDD spaces per channel is 200M/H,if 4channels real time CIF at 24hours recording uninterrupted,it can last: $500G/(200M/H*24H*4ch)=26$ days